

AURORA 9 9 CHANNEL 2.4GHz AIRCRAFT COMPUTER RADIO SYSTEM

Introduction

Section One

Welcome to the Aurora experience!

The Aurora 9 is Hitecs most sophisticated R/C transmitter and allows the user to choose between 72MHz FM, Hitecs QPCM and our new "Advanced Frequency Hopping Spread Spectrum" AFHSS 2.4GHz signal technology.

Hitec developers worked hard to deliver the easiest to program, most flexible 9 channel radio ever made.

The Aurora will fly almost any airframe conceived, heli, glider, glow, gas or electric powered plane. Best of all, the programming is very rational and follows an extraordinary logical path.

We sincerely encourage you to read at least the first couple sections of the manual, as they contain invaluable information created to make your experience with the Aurora a pleasant one.

Content Disclaimer

Please note that Hitec reserves the right to make production changes during the life of our product lines that may impact the information in this manual.

For the most up-to-date information on this and any other Hitec product, visit our web site at www.hitecrd.com.

Hitec RCD Inc. R/C Controller

Model No : AURORA9

POWER : 1. Poser supply from the AC/DC Adapter
input - AC 100 V~240V: 50Hz/60Hz
Output - TX : DC 7.2V : 80mA
RX : DC 4.8V: 80mA

2. Rechargeable Battery : Lithium-ion

Serial No : NONE

This device complies with part 15 of the FCC Rules.
Operation is subject to the following two conditions:

- (1) This device may not cause harmful interference, and
- (2) This device must accept any interference received, including interference that may cause undesired operation.

Manufacturer : HITEC RCD PHILIPPINES, INC
Made in Philippines

9 CHANNEL 2.4GHz AIRCRAFT COMPUTER RADIO SYSTEM AURORA 9

Table of Contents

Section One

Introduction

2	-----	Introduction
3	-----	Table of Contents
6	-----	Steps for Aurora Programming Success
		Using this Manual
		Quick Set-up Guides
		Aurora Software Architecture Explained
7	-----	What's New?
8	-----	Product Support
9	-----	System Component Specifications
9	-----	Glossary of Terms
10	-----	Icon Identification
11	-----	Safety Information
		Warnings
13	-----	Transmitter Battery Information
14	-----	Signal Modulation Options
		SPECTRA PRO 72MHz FM PPM / 72MHz QPCM
15	-----	Hitec 2.4GHz System Set-up
		SPECTRA2.4 2.4GHz Module Features
		Optima Series Receiver Features
18	-----	Set-up and Use
		Range Check Function
		ScanMode Set-up
		Failsafe
		Telemetry System
		SPC (Supplementary Power Connection) System
22	-----	Aurora Transmitter Accessories
23	-----	Aurora Transmitter Controls
27	-----	The First Screen
		Multi-I/O port
28	-----	Home Screen Menu

Section Two

Quick Start Guide to setting up a simple powered airplane or glider.

30	-----	System Menu Programming
34	-----	Model Menu Programming

Section Three

Quick Start Guide to setting up a Heli.

38	-----	System Menu Programming
41	-----	Model Menu Programming

Section Four

System Menu

47	MDL Select	Create a new model Select an existing model Copy one models data into a fresh model memory slot Reset the model memory to factory default settings Rename a model
49	MDL Type	Model type menu, ACRO, GLID or HELI
54	Timer	Menu for Timer 1, 2 and the Integral timer
56	Channel	Model control channel assignment menu.
57	Modulation	Select desired modulation type, 2.4, 72 FM or QPCM
59	TrimStep	Size adjustment menu for the trim steps
60	Trainer	Trainer option menu
62	Power	Transmitter power adjustment menu
63	MODE	Stick mode option menu
64	Info	Transmitter ID information
65	Freq Sel	Select the active models transmit channel while in PPM and QPCM only
65	Sensor	Telemetry menu appearing while in 2.4GHz mode only.

Section Five

Model Menu and more...

Major Super Special Hints

67	Additional Menus, the Custom and Adjust Features
67	Adjustment Menu

The Switch Selection Process

68	Selecting a switch
71	The Adjust function switch set-up
72	Additional camber and launch mode adjust function menu (GLID)
73	Helicopter throttle and pitch curve adjust functions, hover trim and more
74	Trim link Activation
75	Cut position set-up
76	Launch cut switch set-up

Common Model Functions to ACRO, GLID and HELI

77	EPA	End Point Adjustment
78	D/R & EXP	Dual Rates and Exponential (expo) rates
79	Sub-Trim	Servo Sub-trim adjustment
79	Reverse	Servo reversing function
80	S. Speed	Servo Speed feature
80	Monitor	Active model control monitor
81	P. Mixs	Programmable Mixing
83	FailSafe	Servo position FailSafe
84	Gyro	Gyro on/off and Sensitivity Adjustment

Section Six

Model Menu

Common Model Functions to ACRO and GLID

86	FLT.COND	Flight Conditions	
91	Airbrake	Airbrake Function and Landing Mode.	
92	ABR- ELE	Airbrake to Elevator mix	
94	AIL-RUD	Aileron to Rudder mix	
95	ELE-CAM	Elevator to Camber mix	
96	RUD-AIL	Rudder to Aileron mix	
97	AIL DIFF	Aileron Differential feature	
98	AIL- FLP	Aileron to Flap mix	
99	CAMB MIX	Wing trailing edge mix	
100	FLP CON	Flap control mix	
101	V.Tail	V-Tail mix feature	
102	AILEVATR	Split elevator and aileron inclusion mix	
103	Elevon	Elevon or flying wing mix	
104	Fuel Mix	Fuel mixture control adjustment	ACRO only
105	Thro.Cut	Throttle cut position	ACRO only
106	T.Curve	Throttle curve	ACRO only
107	IdleDown	Throttle Idle down position	ACRO only
108	B-fly	Butterfly or "Crow" mix	GLID only
109	SnapRoll	Snap roll function	ACRO only
112	Motor	Glider motor control feature	GLID only
113	Launch	Launch mix	GLID only

Section Seven

Model Menu

HELI Specific Functions

116	FLT.COND	Idle-up and hold / Flight Conditions
122	P. & T. Curve	Pitch curve & Throttle curve adjustment
123	Needle	Carburetor needle function
124	SWH-THR	Swash plate movement to throttle mix
125	RUD-THR	Tail rotor to throttle mix
126	T. HOLD	Throttle hold function
127	SwashMix	Swash plate fine tuning menu
129	REVO Mix	Revolution mix
130	Gyro	Gyro functions
132	Governor	RPM governor adjustment

Steps for Aurora Programming Success

Using the Manual

It is NOT recommended that you read it cover to cover unless you have trouble falling asleep at night. However, the manual will be a fine resource on the methods and programming details of the Aurora. As you use the radio, use this manual!

The Aurora manual is divided into seven distinct sections;

1. Introductory material that is mandatory reading. This is where you will learn detailed information that will be invaluable to successful Aurora programming.
2. Airplane/Glider quick start guide.
3. Heli quick start guide.
4. System menu programming common to all ACRO, GLID and HELI models.
5. Model menu programming common to ACRO, GLID and HELI models.
Additional menus and switch selection process
6. Model menu programming for ACRO and GLID models.
7. Model menu programming specific to HELI models.

Warning, Caution, Note and Tip Boxes

Throughout the manual you will see important information inside a labeled box. Take care to note this information.



Warning



Caution



Tip



Note

Here's a sample;



Warning

If you are unable to accomplish a successful range check of 90 feet, DO NOT ATTEMPT TO FLY.

Quick Set-up Guides

We recommend that you read the introductory information in section one, then jump right into one of the quick start guides and start programming. After following along with the quick start guide you will have a "feel" for the way the Aurora's programming architecture has been laid out. We encourage you to set-up a few aircraft before you fly the Aurora. It will be time well spent and help smooth your passage along the programming learning curve.

Aurora Software Architecture Explained.

Unlike prior Hitec radios, the Aurora features "open" software architecture. Any function can be controlled by almost any switch, slider, gimbal stick or button. To ease your way through the programming, many of the traditional channel choices and control functions are used by default, until you get to the more sophisticated set-ups. By the time you graduate to programming complicated models, you'll be well schooled in programming your Aurora.

As you add more functional choices to a models programming, you may be called upon to tell the Aurora what switch you would like to use for activating functions like retracts, gyros, dual and exponential rates, flight conditions and mixing functions.

The Aurora is a powerful computer. Anyone who has used a computer will acknowledge the only way to really become proficient with any software program is to use it. We at Hitec encourage you to invest several hours in setting-up various airframes before you ever use the Aurora.

Take the time to familiarize yourself with the programming architecture. The flow of the programming will literally pull you through the set-up process. You will find with a little practice, that within a short time you will master the Aurora's capabilities.

What's New?

Many of you have owned or used earlier model Hitec transmitters. Here are seven "new" Hitec transmitter features that set the Aurora apart from all other Hitec products.

1. Signal Protocol

Your Aurora can transmit three different signals, 72MHz FM, QPCM and 2.4GHz.

1. Using Hitecs AFHSS 2.4GHz module to link with Hitec Optima AFHSS 2.4GHz receivers.
2. Use the SPECTRA PRO, 72MHz frequency synthesizer module to fly any brand of 72MHz receiver, on any channel.
3. Select the Hitec QPCM signal option when using the SPECTRA PRO module to use the QPCM receiver on any channel.

2. Touch Screen Programming

Look at me, no buttons! Just press the icon or word on the screen to easily flow through the Aurora programming.

3. 72MHz Synthesizer

Use the new SPECTRA PRO module in your Aurora and select any of the fifty 72MHz channels through the Aurora software. No more taking the module in and out of the radio to change your frequency.

4. Battery Management

The Aurora arrives with a six cell NiMH battery and 110V or 220V charger. It does have the option of using a six cell NiCd, NiMH pack, or a 2 cell Li-Po battery. Using a Li-Po entails removing the battery from the transmitter for charging with an appropriate charger.

5. Gimbals

Feel the silky smooth action of the new four ball bearing supported gimbals in the Aurora 9. These new gimbals were created to give you the smoothest action demanded by the highest performance aircraft.

6. Switch Assignments

During the model programming steps you will be asked to select what stick, switch or slider controls the features you want to use with your model. This gives you unlimited flexibility to choose the most comfortable and practical way for you to use the Aurora.

7. Channel and Control Assignments

The Aurora will automatically select the channel and control assignments based on the model you have. There is the option to change them if you wish, allowing you a wider choice of receivers that can be used with the Aurora.

Product Support

Aurora Programming Support

While every attempt was made by the Aurora's developers to make the software interface easy and logical, most users will require programming help at some point. There are several "get help" options available to you.

Hitec Customer Service

Help is available from the Hitec office through phone support and e-mail inquiries. The U.S. office is generally open Monday thru Friday, AM 8:00 to PM 4:30 PST. These hours and days may vary by season. Every attempt is made to answer every incoming service call. Should you get voice mail, leave your name and number and a staff member will return your call.

Hitec Web Site

Make plans to visit the Hitec web site on a regular basis, www.hitecrd.com or www.hitecaurora.com. It is full of specs and other information about the entire Hitec product line, and our FAQ pages will eventually hold valuable information about the Aurora.

The On-Line Community

One of the benefits of the extensive R/C online community is the vast wealth of archived knowledge available. Hitec sponsors forums on most of the popular R/C web sites where a Hitec staff member or representative tries to answer all manner of product related questions. Bringing together strangers with common interests is proving to be one of the greatest gifts of the internet. If past history is any guide to the future, we are certain forums will be started about the Aurora and several are sure to stand out as valuable archives of information.

Warranty and Non-Warranty Service

All Hitec products carry a two year from date of purchase warranty against manufactures defects. Our trained and professional service representative will determine if the item will be repaired or replaced. You say the 4 year old kid knocked your Aurora off a table? Hitec has an in-house service department to fix our products quickly.

To provide all the necessary information we need to administrate your repair, visit our web site at, www.hitecrd.com and download the repair form, fill it out and send in your item for repair.

Hitec Service
12115 Paine St.
Poway CA 92064

1-858-748-6948

E-mail, service@hitecrd.com

System Component Specifications

Note that the Aurora is available in several different system configurations. Here are the specs for the most common equipment available for the Aurora. For more information on these and other Hitec product specifications visit the web site at, www.hitecrd.com.

Aurora 9 Transmitter

Modulation

AFHSS 2.4GHz	w/SPECTRA 2.4 Module
72MHz PPM	w/SPECTRA PRO Frequency Synthesizer Module
72MHz QPCM	w/SPECTRA PRO Frequency Synthesizer Module

Power Supply : 7.2V NiMH Battery

Current Drain : 300 mA

Optima 2.4GHz Series Receiver

Rx. Model	Size	Weight	Stock Number
- Optima 6	1.65 x 0.82 x 0.44in (42 x 21 x 11.4mm)	0.52oz (15g)	28410
- Optima 7	2.24 x 0.82 x 0.44in (57 x 21 x 11.4mm)	0.60oz (17g)	28414
- Optima 9	1.85 x 1.12 x 0.44in (48 x 28.5 x 15.3mm)	0.77oz (22g)	28425

Operating Voltage : 4.8~7.4V From a receiver battery, or a speed control (ESC) power
4.8~35V Using SPC function

Current Drain : 190mA

Glossary of Terms

AFHSS 2.4GHz signal	Hitec 2.4GHz R/C signal protocol. Adaptive Frequency Hopping Spread Spectrum.
SPECTRA PRO Module	72MHz FM signal synthesizer module used with the Aurora.
SPECTRA 2.4 Module	Hitec 2.4GHz module used with the Aurora.
Optima Receiver	Hitec 2.4GHz receiver brand.
Telemetry	Data signal from the model, transmitted to the transmitter.
Normal Mode	Hitec 2.4GHz transmission signal choice.
Scan Mode	Hitec 2.4GHz transmission signal choice.
link(ID Setting)	Linking or "binding" a 2.4GHz receiver to its master transmitter.
QPCM	Hitec "Pulse Code Modulated" 72MHz FM signal technology.
HPP-22 PC interface	Aurora PC interface accessory.
Multi-I/O format	File sharing, trainer and PC interface mode.
OST	Offset curve feature
EXP	Exponential rate curve feature
Delay	Function initiation speed adjustment

Icon Identification

Icon Identification

MODEL	The model menu contains the model programming for the active model.
ACRO	Menu for fixed wing, glow, gas and some electric models.
GLID	Menu for gliders and some electric models.
HELI	Menu for rotary wing aircraft.
EXIT DOOR	Appears in the upper right corner, the "go back" icon.
FOLDER	The custom menu. Often used, or "quick access" feature folder.
WRENCH	The system menu contains model set-up and transmitter feature menus.
ADJUST	The adjustment menu contains the adjustment features for quick access.
AILE	Aileron for fixed wing menus and the "roll" swash input for helis.
ELEV	Elevator for fixed wing menus and the "pitch" swash input for helis.
RUDD	Rudder for fixed wing menus and the "yaw", or tail rotor input for helis.
1/2, 1/3, 1/6 FRACTIONS	Indicates the number of pages in the menu. Press to access the next page.
+ RST -	Often used Aurora menu value input icons. Value adjustment icon + / -, RST: Reset
Arrow	Press to cycle through menu options.
C	Combination icon. Flight mode option, "groups" the flight mode values.
S	Separate icon. Flight mode option, "separates" the flight mode value.
INH	Inhibit is used to "turn off" a function.
SEL	Select is used to "select" a feature of the displayed menu.
ACT	Active, "turns on" a function.
NULL	"No switch" selected, the function or feature will be "on" all the time.
AUX	An "open" channel, without a control assigned to it.
J1	Right gimbal, up and down control.
J2	Right gimbal, side to side control
J3	Left gimbal, up and down control.
J4	Left gimbal side to side control.
T1	J1 control trim.
T2	J2 control trim.
T3	J3 control trim.
T4	J4 control trim.
LT	Left VR switch.
CT	Center VR switch.
RT	Right VR switch.
RS	Right slider control.
LS	Left slider control.
Multi-I/O	File sharing, trainer and PC interface mode.
DataTran	User can up / down load model setup data thru a PC.
T.Pupil	Aurora in pupil, or training mode.

Safety Information

Flying models can be dangerous if proper safety precautions are not followed. Here are a few critical safety suggestions to keep you and others safe.

Are you experienced?

Flying models is not an intuitive process. Most accomplished model pilots were taught by another modeler. We encourage you to seek help during your early flight experiences and if required, during the building and gear installation process. Unlike some other hobbies, model airplane flying has evolved into a social event. There are approximately 2,500 model aircraft clubs in America. Friendship and help could be right around the corner. Ask your local hobby shop about clubs in your area.

Where to Fly

Having enough land for your own model airport is rare. Most of us fly at club administrated model fields. The local ball field can be tempting but rarely has the space needed and your liability is high should you damage property or hurt an innocent person. We recommend you fly at a sanctioned model aircraft field.

Join the AMA

In America, the Academy of Model Aeronautics (AMA) is an organization of model enthusiasts that provide resources and insurance to modelers. The AMA also lobbies the Government concerning legislation that impact modelers.

Visit their web site for more information, www.modelaircraft.org.

Academy of Model Aeronautics

5151 East Memorial Drive
Muncie, Indiana 47302
Toll Free : 800 435-9262

Fundamental Guidelines for Safe Flying

1. Don't fly over people or personal property.
2. Make sure you do a range and pre-flight check on your aircraft.
3. Check for others flying on your frequency. (No need with 2.4GHz)
4. Know your batteries condition. Keep them charged.
5. The equipment we use in the R/C hobby is sensitive electronic gear. Have receivers checked after a crash before using them in another aircraft.
6. Use the Fail-Safe function in AFHSS and QPCM mode to lower the throttle in case of a signal "lock-out".
7. Don't fly alone.

Aurora Transmitter Warnings

The Aurora has a few warning alarms you need to be aware of.

Start-up warnings

High Throttle

If the throttle is positioned above idle during the system "boot-up to transmit" process, a warning beeping will occur and the following warning screen will be displayed;

[Condition Warning] NORMAL
To transmit radio frequency.
-turn off all switch's condition.
-descend the throttle stick down.

Lower the throttle to proceed.

Condition warning at start-up

If you have flight conditions and other mixing programmed for the active model, and they are switched "on" during the "boot-up to transmit" process, a warning beeping will occur and the following warning screen will be displayed;

[Condition Warning] Cond-2
To transmit radio frequency.
-turn off all switch's condition.
-descend the throttle stick down.

Turn the mixes off to proceed.

In flight warnings

If the transmitter should start a continuous beeping during a flight, land immediately and evaluate the cause of the warning.

Low transmitter battery tone

When the transmitter battery power descends to a critically low level, a warning beeping will occur.

Low aircraft battery tone when using 2.4

If the aircrafts on-board battery is critically low, SPECTRA 2.4 Module will start beeping during its operation.

Transmitter Battery Information

Your Aurora transmitter is supplied with a rechargeable, 6 cell, AA size, 2000mAh Nickel Metal Hydride(NiMH) Eneloop battery pack with a nominal voltage of 7.2V.

Charging

The preferred charging method is to use the supplied CG-S45 overnight wall charger. Plug it into the port as shown in the diagram. Note the red "charging in process light" on the CG-S45 overnight wall charger. This light will turn green when charging is complete. Normal procedure is to charge overnight before flying the next day.

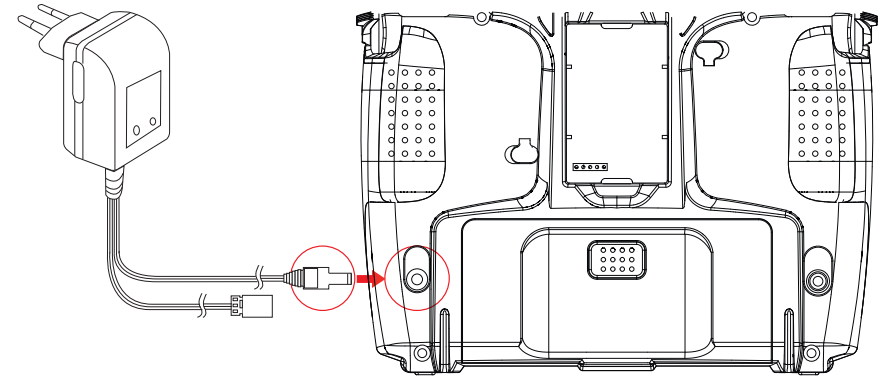

*** Warning: During the Aurora 9's charging process, turn off the transmitter power**

The battery can be removed from the radio and charged with a "quick" charger. The recommended charge rate should be no more than 2 Amps.

Power Meter

There are two ways to review the battery voltage on the Aurora home screen. A "direct voltage read out", and a "percentage of available power" graph can be displayed by touching the power icon on the main menu.



The Li-Po Option

The nominal voltage of a two cell Li-Po or Lithium Polymer battery pack is 7.4V. The user has the option to power the Aurora with a 2S Li-Po but accepts full responsibility to do so safely. To use a Li-Po transmitter battery safely, you must remove the battery from the transmitter case for charging, and reinstall it after charging.



Caution

Do not install a Li-Po in the Aurora and then try and charge it with the supplied CG-XX overnight wall charger. The CG-XX was created for NiMH cells only! Certain major damage is sure to occur.

Signal Modulation Options

The Aurora offers the option to use the SPECTRA PRO 72MHz module for 72MHz operation, or SPECTRA 2.4 AFHSS module for 2.4GHz operations. Please read the following text that explains the installation and set-up process for these two options.

SPECTRA PRO 72MHz

With the SPECTRA PRO frequency synthesizer module, you choose what 72MHz channel you want to use for any of the thirty model memories in the Aurora.

SPECTRA PRO Compatibility

Receiver Compatibility

When used in the Aurora, the SPECTRA PRO will fly models using any brand of 72MHz FM PPM receiver, or the Hitec QPCM receiver.

Transmitter Capability

The SPECTRA PRO will work in the Aurora transmitter only! As of this writing, it is not compatible with any other current R/C product.

Installation of the SPECTRA PRO

- To install the SPECTRA PRO module, make sure the power is OFF.
- Fit the SPECTRA PRO into the module pocket in the back of the Aurora radio case.
- Line-up the pins with the mating connector and gently plug it in until the module is properly seated in the radio case.

How to use the SPECTRA PRO

There are several ways to change a models frequency in the Aurora.



In all cases shown below, PPM or QPCM must be selected as the radios signal modulation.

- At the very first screen, by pressing the channel icon.

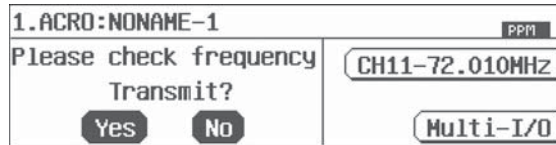

- At the home screen by pressing the CH-XX icon.

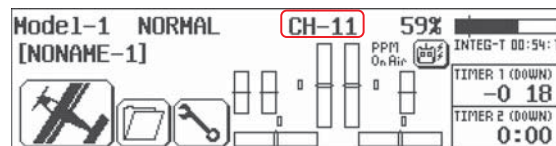

- In the System menu, Freq-Set menu.

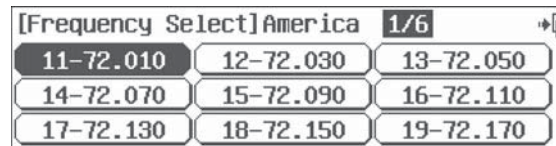

For detailed instructions on changing the channel, consult page 57, the System menu, Freq Set function.

Hitec 2.4GHz System Set-up

SPECTRA 2.4GHz Module Features

The following contains the complete instructions on how to use the Optima 2.4GHz series receivers and SPECTRA 2.4GHz module set for a trouble free 2.4GHz signal. We encourage you to review this information before using these products.

1. Dual Blue and Red Status indicator LED's

Indicates the set-up process codes and use status.

2. Function Button

Used for Linking(ID-Setting) the module to a receiver, entering the power down mode for range checks and the Nomal / Scan Mode set-up.

3. Sensor Data Output and System Upgrade Connector Port

A 3 pin servo plug connector port is featured on the 2.4GHz module. Using the HPP-22 PC interface accessory this port serves to facilitate upgrading the devices software and downloading information from Optima 7 and 9 channel receiver if using optional onboard sensor station.

4. Adjustable Antenna

The antenna is an adjustable two piece unit hardwired to the module.

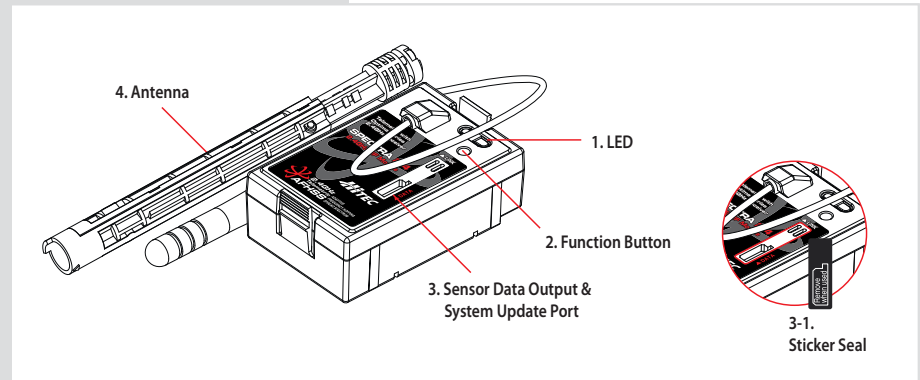

Optima Series Receiver Features

As of this writing, there are three Optima 2.4GHz receivers that are compatible with the SPECTRA 2.4GHz module. The Optima 6, Optima 7 and the Optima 9 channel products are loaded with a variety of functions that are sure to deliver a satisfying R/C experience.

1. Telemetry Sensor and System Port

A three pin servo plug connector port is featured on the Optima 7 and 9 ch. receivers. Using the HPP-22 PC interface accessory this port serves to facilitate upgrading the devices software and interfacing the optional onboard sensor station.

2. Function Button

Used for Linking(ID-Setting) the receiver to a module, entering Fail-Safe / Hold mode setup function.

3. Dual LED Status Indicator

Indicates the set-up process codes and use status.

Hitec 2.4GHz System Set-up

4. SPC Supplementary Power Connection

Power the Optima receiver function with up to a 35V. motor battery. Details about the SPC system can be found on page 21.

5. Channel Output and Battery Input Ports

The ports for battery power, servos, gyros and other accessories are located at each end of the streamlined Optima receivers.

6. Jumpers

The jumper is installed at the factory and is used when the receiver is powered by an electronic speed control, a commercially available B.E.C. (battery eliminator circuit), dedicated 4.8 to 6V. NiMH battery pack, or *2S Li-Po/lo/Fe batteries. The jumper is removed when the receiver is powered using the SPC feature as described in more detail on page 21.



*Verify your servos are rated for use with these higher voltage batteries or use a regulator.

Compatibility

The Optima series receivers are compatible with transmitters using the Hitec AFHSS 2.4GHz system Spectra 2.4GHz module or dedicated non-module AFHSS Hitec transmitters in the future.

Normal / Scan Mode Selectable

Select between two operational signal types. See page 19 for details.

FAIL-SAFE Option

Servos and other accessories may be programmed with a FAIL-SAFE point in the event power to the receiver is interrupted. See page 19 for details.

Onboard Receiver Battery Warnings

Know when your on-board battery is low with direct telemetry feedback to your transmitter. See page 21 for details.

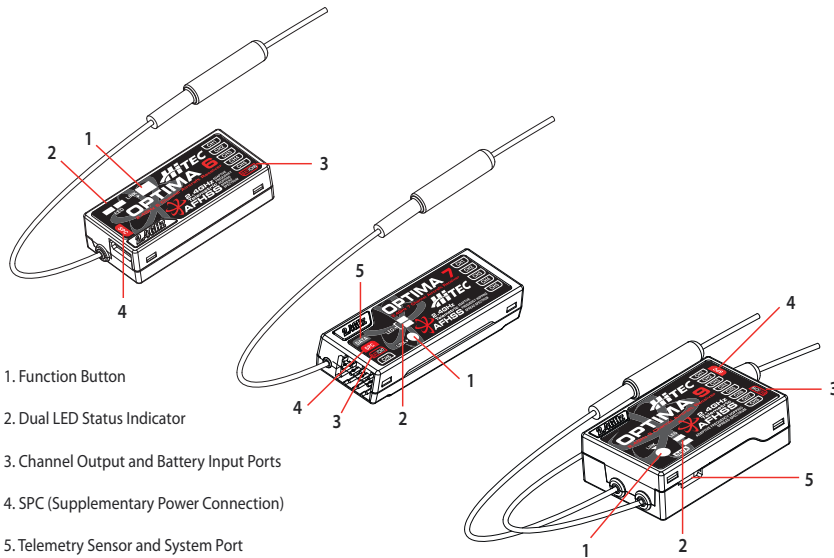

Hitec 2.4GHz System Set-up

Optima Receiver Connection Diagrams

Glow, gas or electric powered aircraft using a separate receiver battery supply.

Follow this connection diagram when using a dedicated 4.8 to 6V. NiMH battery pack, or *2S Li-Po/lo/Fe batteries.



*Verify your servos are rated for use with these higher voltage batteries or use a regulator.

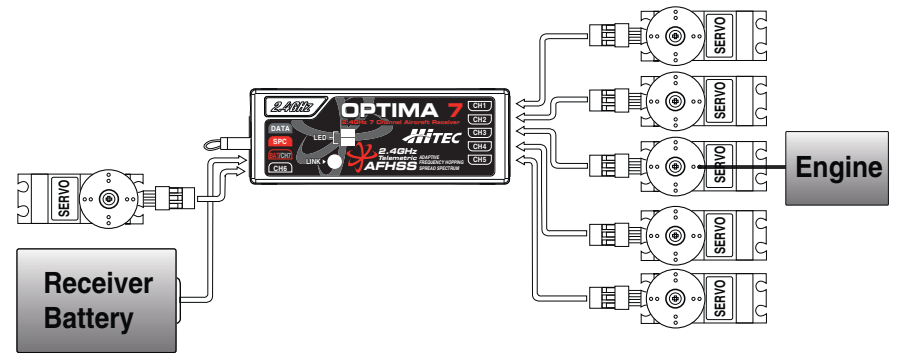

Electric powered aircraft with Electronic Speed Control

Use this method on electric planes using ESC's providing power to the receiver and servo functions.

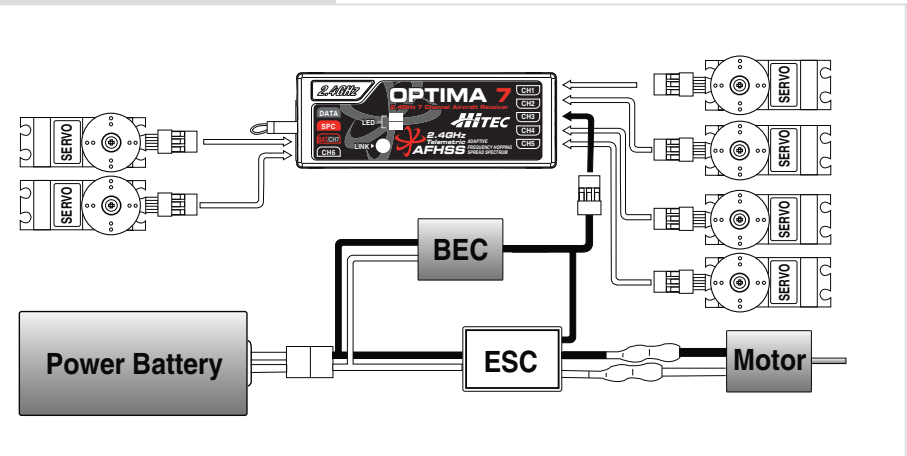

Optional BEC shown in diagram is used if the servo power requirements exceed that which the ESC provides.

Set-up and Use of the Hitec 2.4GHz System



To turn the system on and off, use the following sequence at all times

- Turning On -Turn on the transmitter, select "transmit", then turn on the receiver.
- Turning Off -Turn off the receiver, then turn off the transmitter.

Always do a pre-flight function check

Before the engine or motor is started, turn on the system as explained above. Then make sure all the servos and control surfaces are working properly. If any control surface is not moving properly, do not fly the aircraft until the problem is solved.

Range Check

Do a complete range check as described on page 20 before each flying session to confirm the radio system is working properly.

Your Hitec AFHSS system uses a communication protocol that links and binds the Optima receiver to your Aurora transmitter. Once their ID is set, no other transmitter can interfere with your receiver during its operation. In the case of multiple model memory transmitters like the Aurora, you can bind or link as many Optima receivers to your transmitter as necessary.



Each system and module / receiver set is paired at the factory for your convenience. Use the following Linking (ID-Setting) sequence as you add Optima receivers into other aircraft to be controlled by your Aurora.

ID-Setup A.K.A, binding or linking

Binding when Transmitter is in Normal Mode

- For the Aurora, turn on the transmitter. Press and hold the button on the module, and press Transmit Yes, red LED will flash, release the button.
- Press and hold the button on the receiver, turn on the receiver, red LED is on solid, release the button on the receiver. After receiver is powered-up, the red LED glows solid and the blue LED flash's on the module.
- Turn off receiver.
- Turn off transmitter.
- Turn on transmitter, red LED is solid.
- Turn on receiver, red LED is solid, after a moment the module will beep 4 times very quickly
- You should now have control over the model as the transmitter and module are linked in Normal Mode.

Binding when Transmitter is in ScanMode

- For the Aurora, turn on the transmitter. Press and hold the button on the module, and press Transmit Yes, red LED will flash, release the button.
- Press and hold the button on the receiver, turn on the receiver, red LED is on solid, release the button on the receiver. Solid red and blue LEDs indicator that the receiver is linked with the module.
- Turn off receiver.
- Turn off transmitter.
- Turn on transmitter, red LED is solid, blue LED is blinking.
- Turn on receiver, red LED is solid, after a moment, the blue LED will also come on, and the module emits one long beep.
- You should now have control over the model as the transmitter and receiver are bound in Scan Mode.



- Binding must be done within 15ft. (5m) of the transmitter and receiver.
- Transmitter and receiver need to be at least 18in. (45cm) from each other to binding properly.
- In the ScanMode, if the transmitter or receiver has been shut off or disconnected for more than one second, both module and receiver need to re-boot (turn the power off, and back on).

Set-up and Use of the Hitec 2.4GHz System

Scan Mode and Normal Mode Selection

Hitecs Spectra 2.4GHz module and Optima series receivers have two different operational modes to choose from, "Normal" or ScanMode.

There are available 2.4GHz channels that can be used by your Hitec AFHSS 2.4 system. The following will explain how Normal Mode and ScanMode use the channels.

Normal Mode

- In this mode the receiver/transmitter uses the frequencies which selected at the time it was initially set-up.
- After the initial set-up, the everyday start-up is quicker in the Normal Mode. In 90% of cases the Normal Mode is preferred by users.
- In the Normal mode, if the transmitter or receiver loses power, then power is restored, the system will re-link and function normally.
- The factory default setup is Normal Mode.

Scan Mode

- In ScanMode the receiver/transmitter will scan all available channels every time you turn it on. It will then choose the cleanest frequencies to use. ScanMode is preferable to use when flying in a crowded 2.4GHz environment.
- While in ScanMode if the transmitter loses power it will not rebind to the receiver, if the receiver loses power it will take longer to re-bind than when in Normal Mode.
- In all cases the ScanMode binding function will take longer than in Normal Mode when you boot-up the system.

Changing from Normal Mode to Scan Mode

- Turn on transmitter, then the receiver.
- After linking and you have control over the model, press the button on the module for 6 seconds, you will hear one beep followed by two beeps then release the button.
- The module will now switch to ScanMode noted by the red and blue LED and one beep.
- Turn off the transmitter and receiver.
- Turn the system back on and wait for the system to boot and you have control over the model in ScanMode.

Changing from Scan Mode to Normal Mode

- Turn on transmitter, then the receiver.
- After linking and you have control over the model, press the button on the module for 6 seconds, you will hear one beep followed by two beeps then release the button.
- The module will now switch to Normal Mode noted by the red LED and two beeps.
- Turn off the transmitter and receiver.
- Turn the system back on and wait for the system to boot and you have control over the model in Normal Mode.

FAIL-SAFE and Hold Mode

If you use the FAIL-SAFE function, and set it up properly, should the receiver signal somehow be interrupted or interference were to occur, the servos will move to your pre-set FAIL-SAFE point you previously stored in the receiver during the FAIL-SAFE set-up process.

If FAIL-SAFE has not been activated, the signal is switched off after the HOLD period of 1 sec. This means that the servos become "soft" and remain in their last commanded position under no load (this may equate to full-throttle!), until a valid signal is picked up again.

In the interests of safety, we recommend that FAIL-SAFE should always be activated, and the FAIL-SAFE settings should be selected so as to bring the model to a non-critical situation (e.g. motor idle / electric motor OFF, control surfaces neutral, airbrakes extended, aero-tow release open, etc).

Set-up and Use of the Hitec 2.4GHz System

FAIL-SAFE Setup

- Switch on the transmitter, then the receiver, wait for the system to boot and you have control over the model.
- Press and hold the receiver function button for 6 seconds, release the button. After 2 more seconds both red and blue LEDs blink rapidly.
- From the moment you release the button, the receiver will count 5 seconds during that time move all the transmitter sticks and other controls to the desired FAIL-SAFE positions (e.g. motor idle, control surfaces neutral), and hold them there.
- After 5 seconds the system will save the FAIL-SAFE position. Relax all the control sticks.
- Turn off the receiver, then the transmitter.
- Turn on the system to use it. FAIL-SAFE is now activated.

Testing the FAIL-SAFE Setting

- Move the sticks to positions other than the FAIL-SAFE settings, and then switch off the transmitter. The servos should now move to the FAIL-SAFE positions previously stored, after the HOLD period (1 sec.) has elapsed.

How to turn FAIL-SAFE Off and reactivate the Hold Mode

- Switch on the transmitter, then the receiver. Wait for the system to boot and you have control over the model.
- Press and hold the receiver function button for 6 seconds and release it. After 2 seconds the red and blue LEDs will blink rapidly.
- Immediately press the button and release it.
- FAIL-SAFE Mode is now deactivated and HOLD mode is activated.
- Turn the transmitter off, then the receiver off.
- Turn the system back on to use it.



- If FAIL-SAFE is deactivated, the FAIL-SAFE position settings are also deleted!
- The FAIL-SAFE settings should be checked every time before you run the engine/motor.

Range Check Function

It is critical that before each flight session you perform a range check that confirms the signal between the receiver and transmitter is appropriate. Unlike the FM/PPM or PCM signal radios, 2.4GHz systems use a fixed shorter, stubby transmitter antenna so the traditional method of range checking your system by lowering the transmitter antenna will not work.

We instead use a power-down mode to reduce the transmitter signal strength. Once the power-down mode is activated it runs for about 90 seconds, shortening the effective range 100 feet (30 m). During this power-down mode that you should walk away from the secured aircraft carrying the transmitter to a distance of approx. 30 meters, testing the effective range.

How to use Power-Down

- Press the button on the module for 3 seconds, then both the blue and red LEDs will turn on with single beep sound. Release the button. The 90-second countdown starts from the time the button released.
- Walk away from the secured aircraft carrying the transmitter to a distance of approx. 100 feet (30 m), testing the effective range.
- To exit the power-down mode before the 90 seconds, press the button again to escape.



- If you are unable to accomplish a successful range check of 90 feet, DO NOT ATTEMPT TO FLY.

Set-up and Use of the Hitec 2.4GHz System

Telemetry System

Currently there are two direct feedback telemetry functions available in your Hitec 2.4 system. Plans are to have many more devices available in the future. Check the Hitec web site at www.hitecrd.com for more up-to-date information.

I. Low Battery Warning

The 2.4 system will automatically recognize the receiver battery voltage among 4 and 5 cell NiMH or Nicad packs and 2S Li-Po/Lo/Fe batteries packs.

- When battery level is high (4 cell > 4.5V, 5 cell > 5.6V): The red module LED glows constantly.
- When battery level is low (4 cell < 4.5V, 5 cell < 5.6 V): blue LED glows constantly and the red LED will blink fast. You will hear a continuous loud beep from the module as a low receiver battery warning. Upon hearing the alarm, we advise you to land at once.



The low battery voltage warning can be custom programmed with the HPP-22

SPC (Supplementary Power Connection) System

Hitec's exclusive optional receiver power system allows you to directly power the receiver from the main motor power battery of an electric powered aircraft. Up to 35 Volts can be fed directly into the receiver to power JUST THE RECEIVER FUNCTION. It will not power the servos. Almost all servos will burn-up if more than 6 Volts are used over a short period of time.

Note; some Hitec servos are rated to be used at 7.4Volts. You will still need to supply power for your servos with a four or five cell NiMH receiver battery, 2 cell Li-Po and regulator set-up, or a commercially available BEC. The SPC system was partially created to be integrated into future Hitec telemetry system devices. Check the Hitec web site for more information on the availability of telemetry systems in the future.

SPC Receiver Connection Diagram

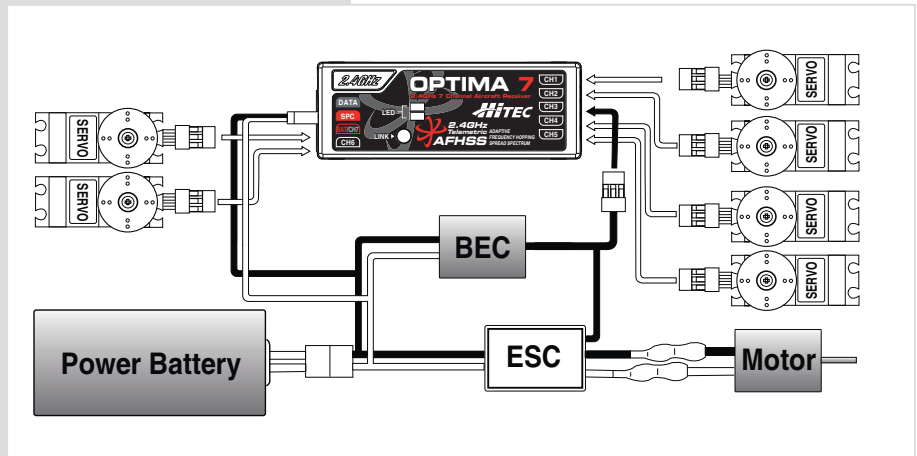

AURORA 9 9 CHANNEL 2.4GHz AIRCRAFT COMPUTER RADIO SYSTEM

Aurora Transmitter Accessories

There are several accessories available for your Aurora transmitter. Check the Hitec web site for information as more accessories are added to the Aurora and Hitec 2.4GHz system product lines.

Modules

SPECTRA 2.4	Hitec AFHSS 2.4GHz System	Part # 28315
SPECTRA PRO	72MHz Synthesizer	Part # 23772

Transmitter Battery Pack

6 cell, 1300mA NiMH Pack Part # 54128

HPP-22 PC Interface

Used to interface the Aurora with a PC, it will offer a variety of functions including updating the Aurora with future software versions, Part # 44470

Neckstrap

Many pilots prefer to use a neckstrap when flying. Hitec offers our comfortable strap and swivel snap neckstrap for the Aurora, Part # 58311

Trainer Cord

The Hitec trainer cord, system can be used to link two Hitec transmitters together for flight training purposes. Part number # 58321 includes the complete trainer cord assembly.

Gyros

We recommend the Hitec HG-5000 gyro but the Aurora was created to use almost any popular gyro available on the market. Standard Economy Gyro Pack (HG-5000 Gyro, HSG-5083MG Gyro Servo, Three HS-65HB) Stock # 40105
Standard Metal Gear Pack (HG-5000 Gyro, HSG-5083MG Gyro Servo, Three HS-65MG) Stock # 40103
Pro Heli Pack (HG-5000 Gyro, HSG-5083MG Gyro Servo, Three HS-5065MG) Stock # 40101

Battery Charger

To charge the supplied NiMH transmitter battery. Use the CG-545 battery charger. Part # 44450 (for 110V)
Use the CG-535 battery charger. Part # 44350 (for 220V)

Servo Installation Wiring

Hitec offers a variety of light and heavy duty servo installation wiring. "Y" harnesses, extensions, small and large switch harnesses are all available from your hobby dealer.



It is strongly recommended to use Hitec "S" Heavy Duty High Channel Switch Harness with Receiver Charger Cord (Stock # 54407S) for Optima series Receivers.

Receivers

Hitec 2.4GHz System
When using the SPECTRA 2.4GHz System Module, any Hitec Optima series receiver can be used.
Optima 6 Part # 28410 Optima 7 Part # 28414 Optima 9 Part # 28425

72MHz FM PPM and Hitec QPCM Receivers.

The SPECTRA PRO frequency module allows the use of all positive or negative shift 72MHz band receivers. The Hitec QPCM receiver format is also supported in the Aurora, part # 191721.

Servos

Any brand of modern servo with a 1.5 ms neutral position can be used with the Aurora. This includes any prior, or current Hitec manufactured servo.

9 CHANNEL 2.4GHz AIRCRAFT COMPUTER RADIO SYSTEM AURORA 9

Aurora Transmitter Controls

1. A, B, C, D, E, F, G, H, switches
2. J1, J2, J3, J4 gimble
3. Neckstrap hook
4. LS and RS sliders
5. All Digital trims, T1, T2, T3 and T4
6. On-Off switch

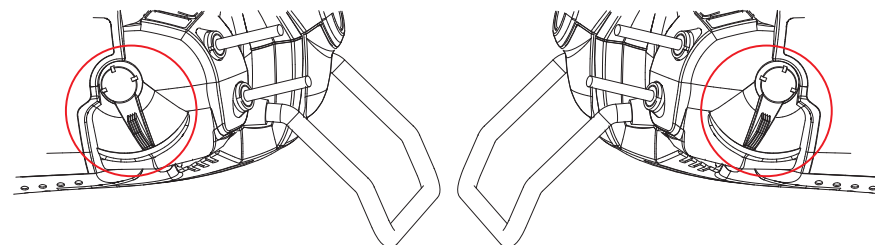
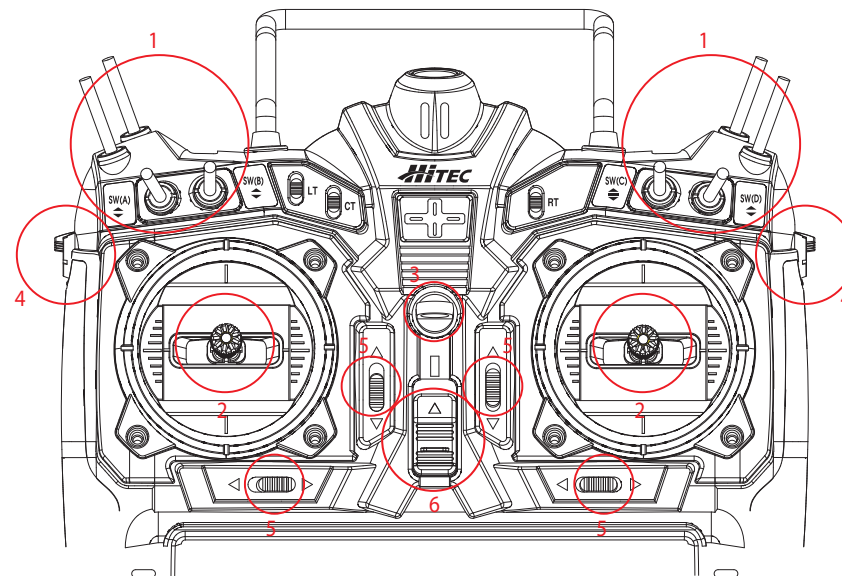

Slider Volumes

Side sliders are used as variable controls on several of the functions by default but can be changed if you wish. Like all of the Aurora controls, you can choose an almost infinite number of control layouts.

Aurora Transmitter Controls

LT, CT, RT Switches

These switches can be used as a channel control and are used as adjustment controls for fine tuning many of the Aurora features.

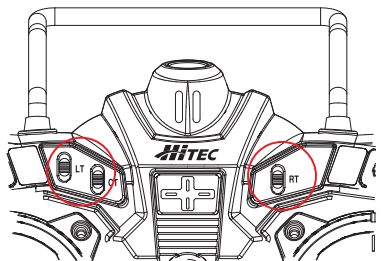

Digital Trims

The Aurora features digital trims on the face of the transmitter for throttle and the three main control functions of pitch, roll and yaw.

- A gentle pull to one side of the switch will cause the control surface to move one trim step and the radio to “beep” once.
- Hold the switch over to one side to rapidly trim a control surface.
- The size of the trim step can be adjusted in the System – TrimStep function menu.
- The graph on the screen will indicate how much movement is applied to the control surface by the trim function.
- Last trim position will be saved in memory should you switch to another model.

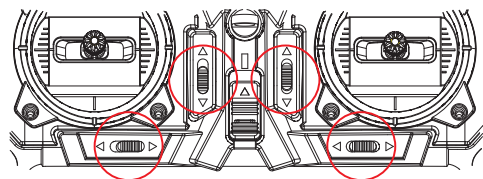

Stick Length Adjustment

Hands come in all sizes so to accommodate everyone we use a two piece stick “top” that can be adjusted to fit a wide variety of users.

- Separate the top from the bottom piece and adjust the top piece to the length required.
- Screw the bottom up against the top piece to “jam” lock everything into position.

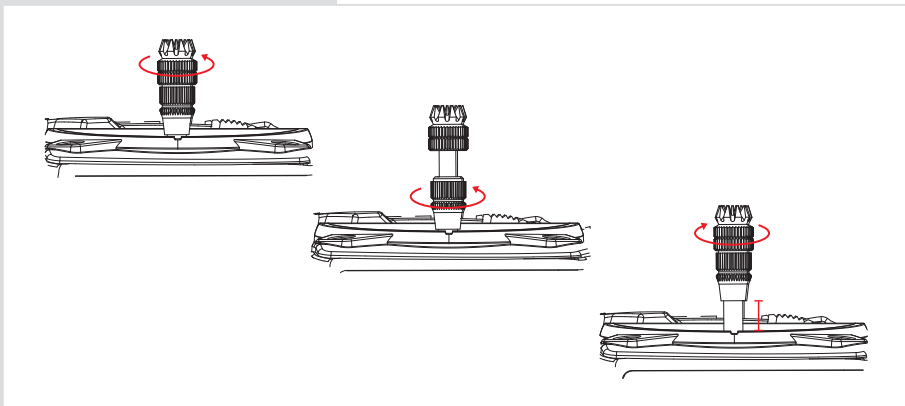

Aurora Transmitter Controls

Stick Tension Adjustment

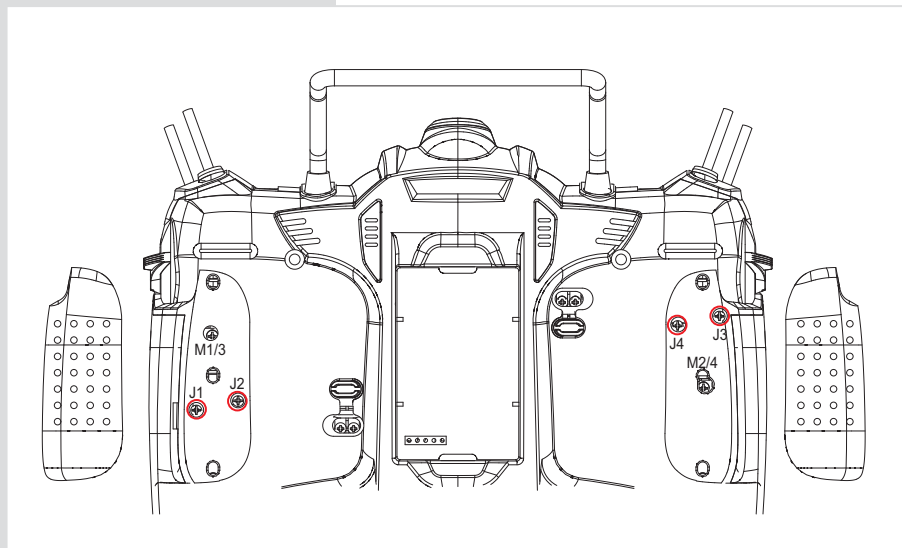

- Remove the rubber pads by gently pulling up a corner and slowly pulling them off.
- Use a small Phillips head screwdriver to turn the adjustment screw clockwise to increase the spring tension, and counterclockwise to decrease the tension of the spring.
- Fit the rubber grip pads back into place when finished.

Control Mode Changes

The Aurora offers unlimited options when customizing the gimble control functions for Mode 1, 2, 3 and 4 users. In addition the Aurora also features two manual mode set-up menus. These are all located in the System – Mode function menu. Refer to page 63 for a detailed explanation on how to select the mode you wish to fly.

- Easy ratchet adjustment for the throttle on each gimble.
- The radio is factory set-up for Mode 2 users in America.

Aurora Transmitter Controls

Stick Ratchet Adjustment

Throttle ratchet tension can also be adjusted to accommodate different flying styles. Some users prefer a very stiff, positive detent in the throttle stick; while heli users often use a very light, sometimes smooth throttle/collective stick "feel".

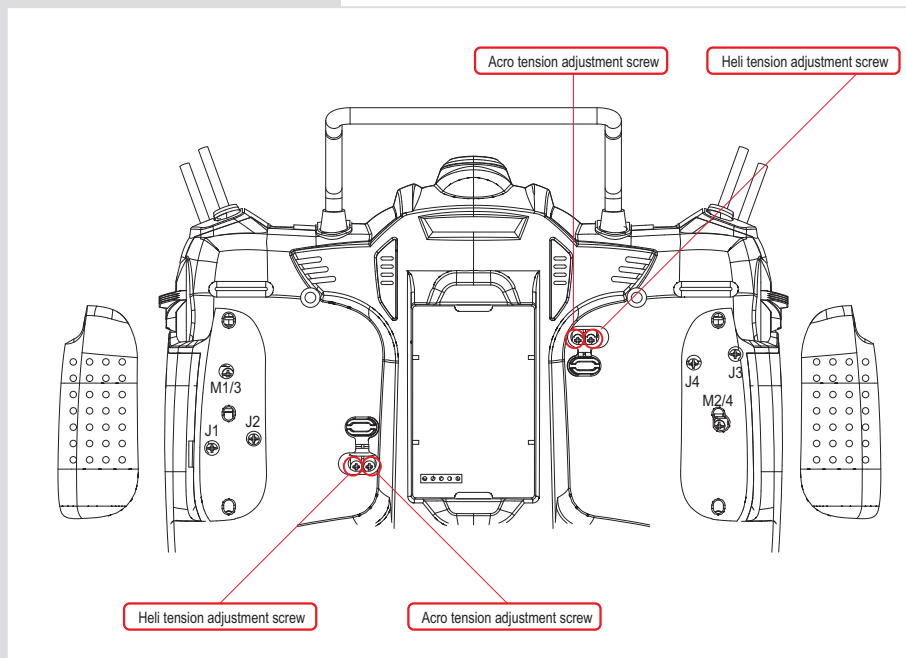

- Peel up the correct rubber dust cover over the throttle stick tension adjustment screws for the mode you are flying. The radio is factory set-up for the popular mode 2 control format.
- There are two adjustment screws. Note in the diagram which one you want to adjust.
- Use a small Phillips head screwdriver to turn the adjustment screw clockwise to increase the ratchet tension, and counterclockwise to decrease the tension of the ratchet.
- To switch from airplane to heli, or heli to airplane, turn the appropriate screw counterclockwise until the stick movement is smooth, then turn the other screw clockwise to apply ratchet pressure and adjust as necessary.

The First Screen

When you first turn on the Aurora, depending on if the radio is in 2.4GHz or the 72MHz format, the following screen will appear.

In 2.4GHz mode;

1. The upper line has the number and name of the active model on the left.
2. The AFFHS 2.4GHz bandwidth you are using appears in the upper right corner, with the signal type below it, either NORMAL or ScanMode.
3. You are prompted to "Please check frequency" and asked to "Transmit" by selecting the Yes or No icon.

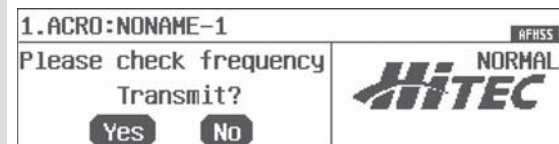

In 72MHz mode;

1. The upper line has the number and name of the active model on the left.
2. The bandwidth type you are using appears in the upper right corner, with the signal type below it, either PPM or QPCM.
3. The channel of the active model is displayed on the right. Press the frequency number icon to enter the Frequency menu. See page 57, for detailed instructions on changing the frequency.
4. You are prompted to "Please check frequency" and asked to "Transmit" by selecting the Yes or No icon.

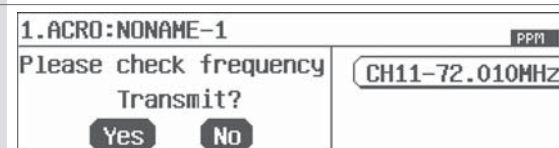

First Screen Additional Menu

The Multi-I/O port

There is one more feature of the first screen to share with you, the Aurora displays a Multi-I/O format that is accessed in the first screen of both the 2.4 and 72MHz format.

To access the Multi-I/O port screen;

- a. Plug in the trainer cord or HPP-22 PC interface in the "trainer" port.
- b. Turn on the Aurora.
- c. Press the Multi-I/O port icon to access the menu.
- d. Press **DataTran** icon for transfer data between radios or save/load data from /to a PC.
- e. Press **T.Pupil** icon to set the AURORA as student mode.

Note : In the pupil mode some functions will be restricted.

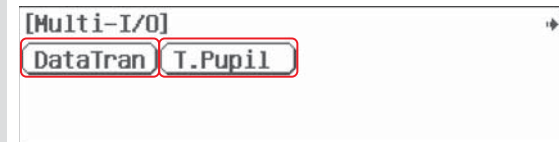
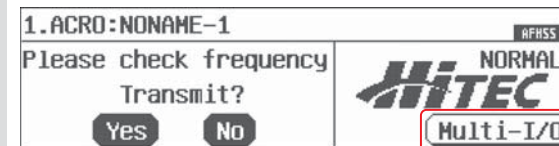

Home Screen Menu

DataTran

Select Data Tran to transfer model set up data between two AURORA's, or to save or load data to a PC.

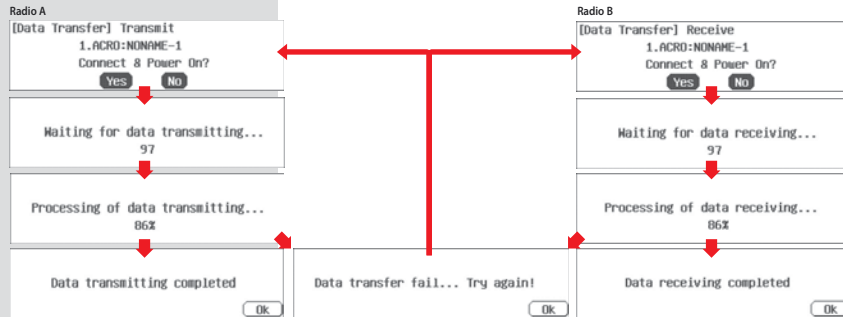
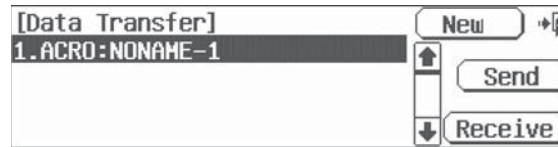

T.Pupil

Selecting T.Pupil forwards the radio into the home screen in the training mode. This is used to place an Aurora in the student format. This function is not used when the Aurora is to be used in the master format. For more information on how to use the Aurora training system mode, see page 60.

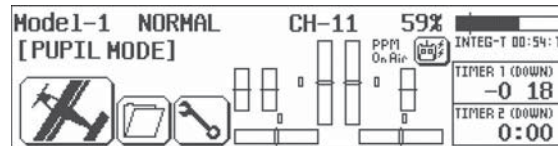

Home Screen Menu

Many of the common functions can be selected for manipulation from the Aurora home screen by pressing their icon. Here are the definitions of the Home screens icons. Please note that most of these functions are explained in greater detail within this manual.

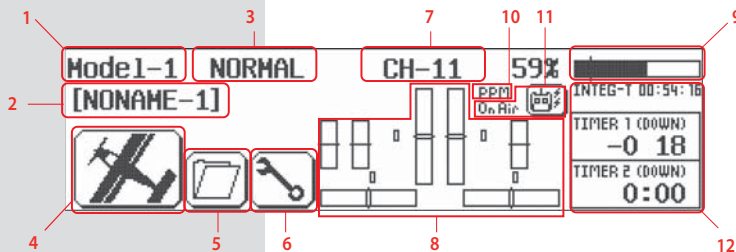

1. Model Number

- Displays the current model memory slot number, 1 through 30.
- Press to select the model choice menu.

Home Screen Menu

2. Model Name

- Displays the current models name.
- Press to select the model choice menu.

3. Flight Condition

- Displays the current flight condition for the active model.
- Press to access the flight condition menu.

4. Aircraft Type Icon

- Will be either ACRO, GLID or HELI depending on active model type selected.
- Press to access the Model function menu.

5. Custom Folder

- Contains model functions copied over to the Custom folder for the active model.
- Press to select the Custom menu.

6. System Menu

- Press to access the System functions menu for the active model.

7. Channel Number

- Appears when the Aurora is used with the SPECTRA PRO module and PPM or QPCM is the selected modulation format.
- Shows the transmit frequency channel number for the active model.
- Press to access the channel choice menu.

8. Digital Trim Position Indicators

- Shows the position of the digital trims on the throttle and three main flight controls, roll, pitch and yaw.
- Press to access the sub trim menu.

9. Power Bar Indicator

- Press to select between % of power left or voltage displays.

10. Signal Modulation

- Will show the signal type selected for the active model, PPM, QPCM or AFHSS.

11. Active or Inactive Transmitter Icon

- Displays the transmitters transmit status.
- If the icon is dark, the Aurora is not transmitting.
- If the icon is clear with lighting bolts and the "on air" text, the Aurora is transmitting.



12. INTEG-Timer

- Displays the "total time on" for your Aurora transmitter. Can be reset in the Timer menu. Timer 1 and Timer 2
- Press to access the timer 1 and 2 menus.

The 2.4GHz operation home screen is a little different, with the following information;

13. Receiver Battery Power Indicator

- Displays receiver's battery level
- * Available for Hitec AFHSS 2.4GHz system only.



Quick Start Guide to Set up a Simple Powered Airplane or Glider

Section Two

To help you get the maximum benefit from your Aurora, we will guide you through a simple set-up of a standard sport plane. The operations shown during this exercise will help you learn many of the basic programming steps required by most of the Auroras features.



If you are setting-up a powered or un-powered glider, we will be programming your plane into the ACRO menu for our demonstration. Later you can explore the functions found in the GLID menus.

Receiver channel assignments are;

Simple Powered Plane with one or two aileron servos.

- #1 Aileron
- #2 Elevator
- #3 Throttle
- #4 Rudder
- #5 Second Aileron (if used)

Simple two channel un-powered glider.

- #1 Aileron (plug your rudder or aileron servo in ch. 1)
- #2 Elevator

After installing the servos and accessories in your aircraft, follow these steps to set-up your first airplane.



For safety reasons during this set-up exercise on an electric powered plane, remove the propeller.

System Menu Programming

- Turn on the transmitter; do not turn on the airplane.

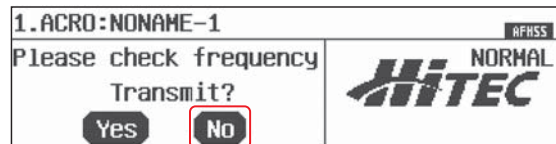

- The first screen is the transmit option, select **No**.

- This is the home screen; select the **wrench icon** for the System menu.

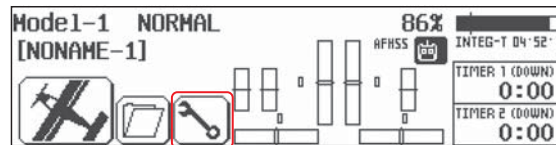

- Note the system menu function choices, select, **MDL Sel.**

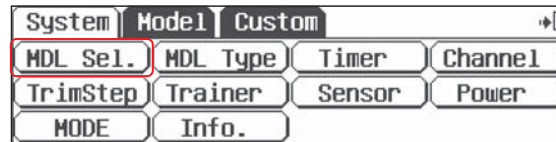

System Menu Programming

- At the model selection screen press, **New**.

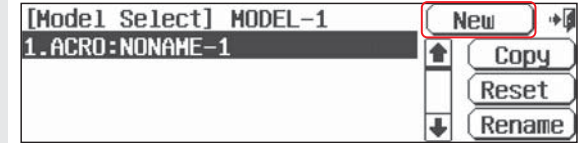

We are programming a new model into the model memory slot number two, not the model memory slot one. For the purpose of this exercise it will ensure a fresh model memory with no existing programming.

- Select, **Yes** to confirm the selection of a new model.

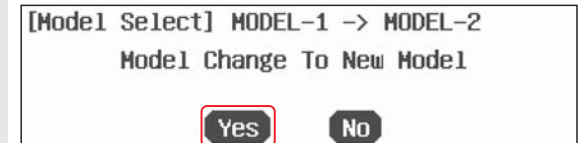

- At the Model naming menu, name your new model using the keyboard.
 - Press **Shift** to see the other characters.
 - When done press, **Enter**.



- Here at transmit option screen, press, **No**. We do not wish to transmit yet.

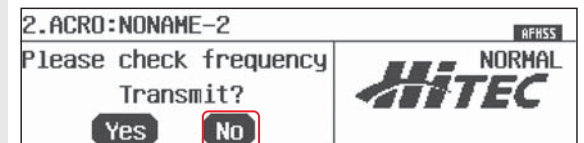

- Next you are drawn into the model type screen where we select **ACRO** (the airplane icon on the left).



- Select change to ACRO, **Yes** at the model type change confirmation screen.

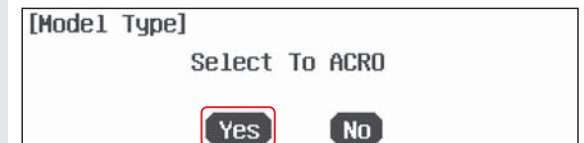

System Menu Programming

11. Here is the screen that will tell the transmitter what kind of wing your plane has.

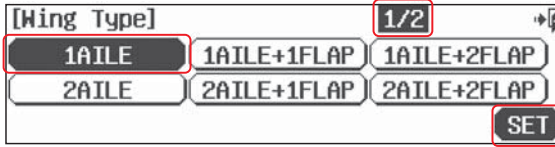

There is a 1/2 icon in the upper right of the screen. This means there are two pages in this menu. Touch the 1/2 icon and note the second screen has even more wing type selections. Many function menus will have more than one screen of options. Check for the 1/2, or fraction icon as you program your plane into the radio.

- a. For our sample plane, you must select how many servos your wing has and what they control. Select 1/AILE if you have one aileron servo controlling both ailerons. OR 2/AILE if your plane has 2 aileron servos in the wing.
- b. Then press the SET icon.



Depending on what you select in this, and for the following menu choices, the radio will automatically optimize the functions for your choices. In other words, if you select a wing type without flaps, there will be no flap function control options in that model memories programming.

12. Next select your planes tail type.

- a. Select Normal.
- b. Again press SET.

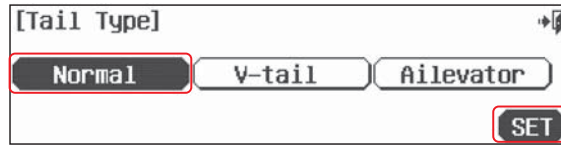

13. At the engine type screen,

- a. Select Single Engine.
- b. Press SET.



14. Retracts? Press No.

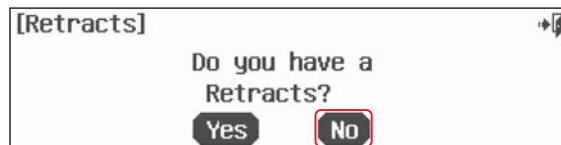

15. Airbrakes? Press No.

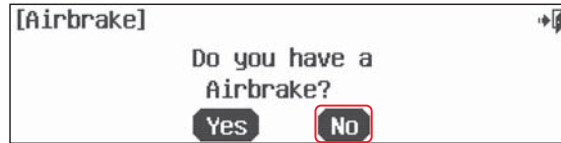

System Menu Programming

16. Fuel Control? Press No.

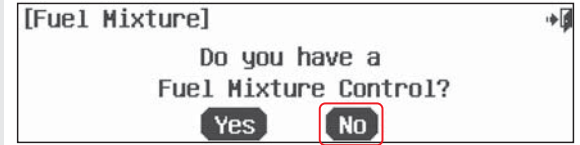

17. Ok here are the channel assignments the radio has selected for you. They should be appropriate. Select Yes.



18. These are the control functions the radio has selected for you. They should be fine. Select the back (Exit) icon at the screens upper right.

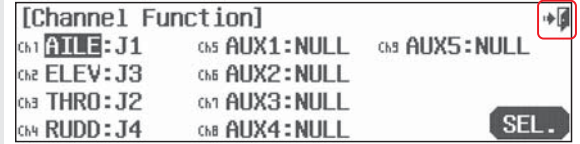

19. This is the model type screen showing the functions we selected. Select the back (Exit) icon at the screens upper right.



20. We are now back to the model select screen. Back out of it with the Exit icon at the screens upper right.

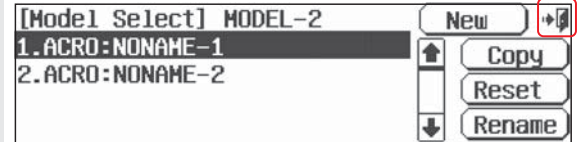

21. Back to the system menu page, and one more time, press the Exit icon.

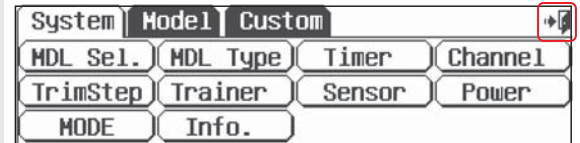

22. Here at the home page take little break, turn off the transmitter and prepare your model to be set-up.

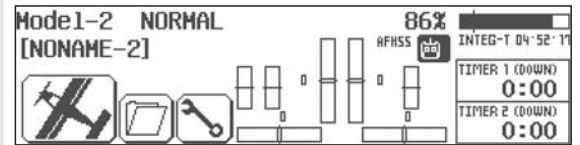

Model Menu Programming

Ok, are you ready? You have your model all prepared and ready to program? Let's go!

23. Turn on the transmitter, select **Yes** to transmit.

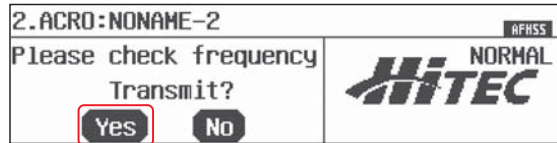

24. At the home page, let's select some model functions by pressing the **plane** icon at the lower left of the screen.

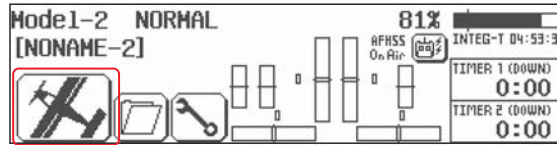

Throttle Lock

The Aurora features a "throttle lock" function that can be activated when the transmitter is transmitting a signal. We encourage you to apply the throttle lock as a safety precaution against "accidental throttle application".

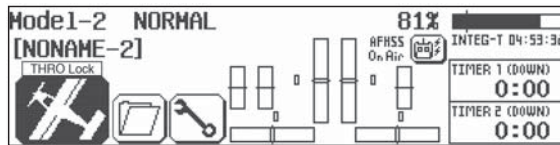

a. Turn the throttle lock on and off from the home page by pressing the **Model** icon for two seconds. Throttle lock is confirmed when the "THRO Lock" icon is displayed.

25. The model menu is one of those "two page" screens, note the **1/2** icon. Here are all the functions the Aurora can apply to our rather simple selected model.

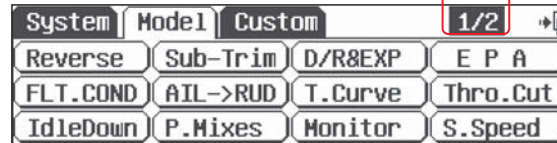

Now turn on power to your model. Within a moment, you should have control over your model with the transmitter.

26. Select **Reverse** from the model menu

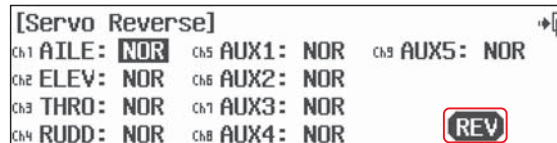

- Move your controls, are all the servos going in the correct direction? If not, select the channel to reverse, then press the **REV** icon.
- Press **Yes** when asked "Sure?"
- Do this until all servo throw directions are correct.
- Back up to the model menu by selecting the **Exit** icon.

Model Menu Programming

27. Select **Sub-Trim** from the model menu

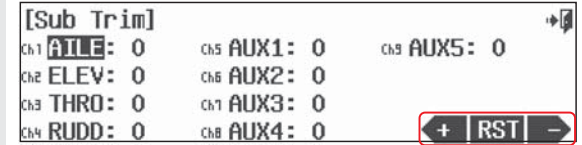

Your servo control arms should be as close to 90 degrees as possible, and the control surfaces as close to level as you can make them by adjusting the control linkages. Sometimes small adjustment must be made to "center" the control surface using the sub-trim function.

- Select the control/channel to adjust by pressing its icon.
- Using the **+ RST -** icon at the screens lower left corner, adjust a value as necessary by selecting the plus or minus icon. Select **RST** to bring the value back to zero if you wish. You should see the control surface moving as changes are made with the **+ or -** icon.



Sub trim is not the place to do a major adjustment. Any servo needing more than 40 points of movement should be adjusted by moving the control horn or adjusting the linkage.

- Follow this procedure for any channels requiring sub-trim.
- When done, back up to the Model menu by selecting the **Exit** icon.



Using the following functions are not mandatory. For the purpose of our quick set-up guide tutorial they will explain most of the fundamental programming techniques available in the Aurora. We highly suggest you follow along with programming the EPA, dual and exponential rate functions. Doing so will teach you valuable lessons and the basics you need to get the most out of your Aurora.

28. Select **EPA** from the model menu

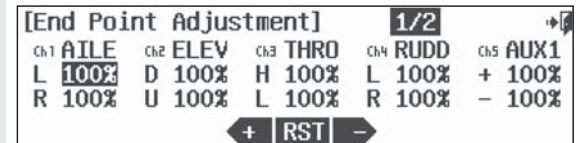

EPA stands for "end point adjustment". With the EPA function you can set the servo arm travel distance by lengthening or limiting how far the arm moves. This function can help avoid binding or damaging the aircraft control surfaces, if set-up properly.

In our example we will adjust the channel 1 aileron servo.

- Move the aileron control stick all the way to the left. The **R 100%** should be highlighted.
- Using the **+ LST -** icon set an appropriate value, more than 100% to increase the travel, or less than 100% to decrease the servo arm travel.
- Now move the aileron stick all the way to the right and set the travel value for the right side.
- Press the 100% value icon for any other channel you wish to set an EPA value for and follow steps a-c.
- When done, back up to the model menu by selecting the **Exit** icon.

Model Menu Programming

29. Select **D/R&EXP** from the model menu

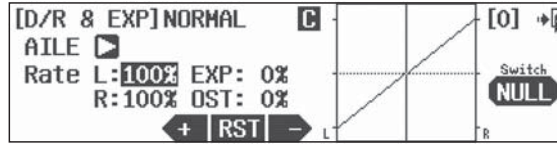

This screen holds two valuable functions, dual rates and exponential rates. Both functions are controlled at this screen.

Using the dual rate function allows you to select a switch that can change the travel rates or distance the servo arm moves a control surface.

We will first demonstrate dual rates, then show you how to program exponential rates.

A good example is that; even a very fast plane must take off and land at a relatively slow speed compared to how fast it may fly at full throttle. What is needed are two servo arm travel rates, dual rates, that we can program and then use a switch to select between these rates. When flying slow, full control movement is necessary, we will call this "high rates", and it is what you currently have set-up based on the EPA values.

When flying very fast, small tiny movements of the control surface are required. We will call the small movements "low rates". Since we already have our high rates set-up, let's set another rate, or servo arm travel distance that is smaller and will give us small control surface movement. This "low rate" can be activated by selecting a switch when you are flying.

Here is how to set up your aileron and elevator travel using the dual rate functions.

- The first control surface to change is the aileron; AILE pops up as the active function when entering this screen.
- Select "Rate" to highlight both R&L. This allows you to change both sides of the servos travel rate at the same time.
- Move the aileron stick to the left, hold it there and press the - icon until you reach 75%.
- Now select a switch that we can throw while flying that will cut the aileron travel down to our 75% setting.
- Press the **NULL** icon to select the switch for our dual rate function.

30. At the intermediary switch screen press the **SEL** icon.



31. This is a map of the Aurora switch layout. You can put the aileron dual rate function on any of the switches shown.

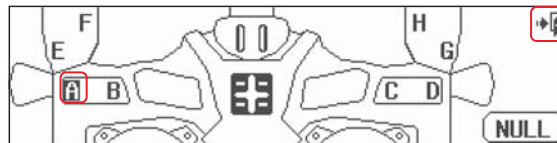

- Let's select switch "A".
- Select the **Exit door** icon twice to back out.

Model Menu Programming

32. Now we are back to the D/R&EXP screen.

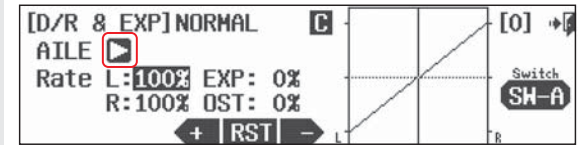

- Run through the same steps to select a dual rate for your elevator.
We change to the elevator function by pressing the **arrow** icon to the right of AILE.
Now it should read ELEV.

33. Follow steps 29-31 to program a 75% value for the elevator dual rate. Select the elevator dual rate to be active by assigning it on the same switch, "A" for the purpose of our demonstration. Be sure to put the 75% elevator value on the same switch "position" as our 75% aileron value.

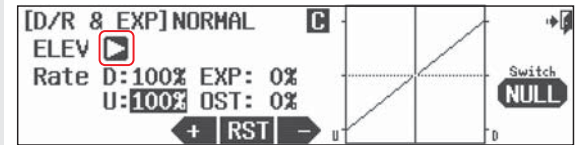

34. Using Exponential Rates

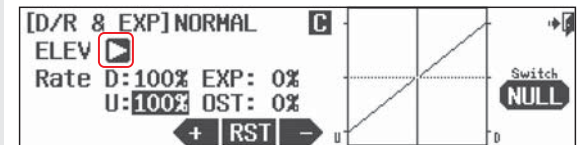

Now we can apply exponential rates to the aileron and elevator controls.

Using exponential rates allows you to shape the normally linier movement of a control surface. Our goal is to soften the middle of the stick around the center point for the "high rates". You will see this curve shaped on the graph displayed on the screen. Using negative expo values will help any pilot fly smoother on high rates, with greater control over their aircraft.

We will apply a -40% value to the expo setting for both the aileron and elevator high rates.

- Apply expo to your aileron control by selecting the AILE controls using the control select **arrow**.
- With the switch "A" in the position that gives us our high rate setting of 100% travel in dual rates, touch the **EXP 0%** icon to activate it.
- Now press - to apply a -40% value. See how the curve of the aileron servos movement changes to "soften" the center of the aileron control sticks travel.
- Change to the elevator again by pressing the **arrow** to the right of the AILE.
- Repeat steps to program our -40% EXPO value for the elevator high rates.

Now by throwing one switch, you can select to use dual rates and have expo on your elevator and ailerons.



For more advanced users, different expo and D/R values can be applied with individual switches and/or under multiple flight conditions.

Your plane should now be ready to fly. Do a range check and pre-flight, then go have fun!

Quick Start Guide to setting up a Simple Heli

To help you get the maximum benefit from your Aurora, we will guide you through a simple set-up of a common collective pitch 120CCPM heli. The operations shown during this exercise will help you learn many of the basic programming steps required by most of the Auroras features.

Channel assignments are;

- #1 Aileron or "roll" cyclic
- #2 Elevator or "pitch" cyclic
- #3 Throttle
- #4 Rudder or tail rotor pitch
- #5 Gyro function
- #6 Pitch Collective

After installing the servos and accessories in your heli, follow these steps to set-up it up.

System Menu Programming

1. Turn on the transmitter; do not turn on the Heli.



For safety reasons during this set-up exercise on an electric powered heli please remove the blades and/or un-plug the motor from the speed control.

2. The first screen is the transmit option, select **No**.

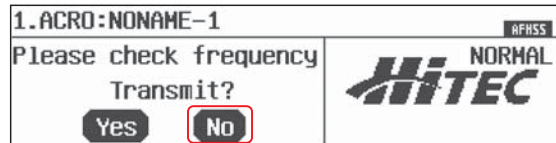

3. This is the home screen; select the **wrench** icon for the System menu.

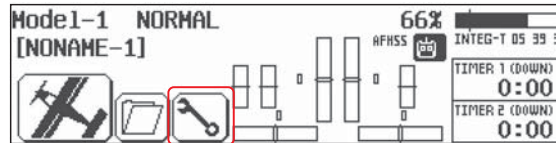

4. Note the System menu function choices, select, **MDL Sel.**

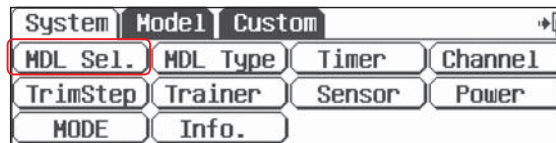

5. At the model selection screen press, **New**.

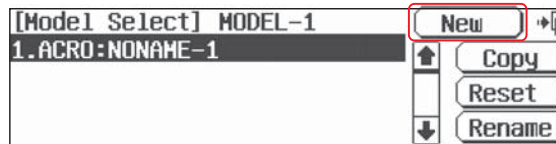

System Menu Programming



We are programming a new model into the #2 model memory slot, not the model memory one slot. For the purpose of this exercise it will ensure a fresh model memory with no existing programming.

6. Select, **Yes** to confirm the selection of a new model.

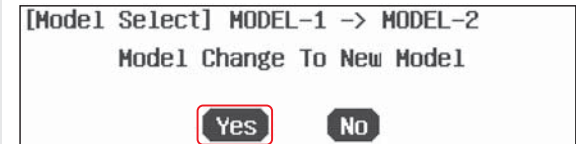

7. At the model naming menu, name your new model using the keyboard,
a. Press **Shift** to see the other characters.
b. When done press, **Enter**.



8. Here at transmit option screen, press, **No**. We do not wish to transmit yet.

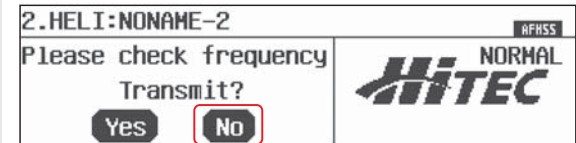

9. Next you are drawn into the model type screen where we select **HELI** (the heli icon on the right).



10. Select change to HELI, **Yes** at the model type change confirmation screen.



11. Here is the screen that will tell the transmitter what kind of swash type your heli uses.



System Menu Programming



There is a 1/2 icon in the upper right of the screen. This means there are two pages in this menu. Touch the 1/2 icon and note the second screen has even more swash type selections. Many function menus will have more than one screen of options. Check for the 1/2 icon as you program your heli into the radio.

a. For our sample heli, you must select what swash type your heli uses. Most will select 120 or 90 degree CCPM swash type. Consult your heli manual to find out what swash type your heli uses. Then press the SET icon.



Depending on what you select in this, and for the following choices of this menu, the radio will automatically optimize the functions for your choices.

12. Governor? Press **No**.

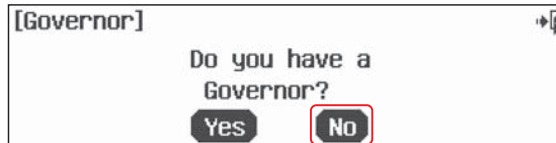

13. Needle control? Press **No**.

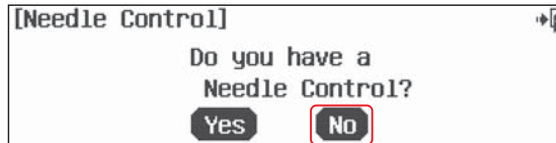

14. Mixture Control? Press **No**.



15. Ok here are the channel assignments, the radio has selected for you. They should be appropriate, select **Yes**.



16. This screen lets you change the control function, for now, select the back (Exit) icon at the screens upper right corner.

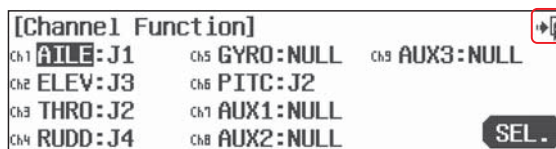

System Menu Programming

17. This is the model type screen showing the functions you selected. back out fo it with the **Exit** icon

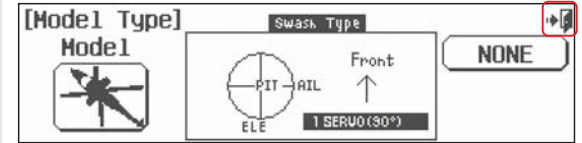

18. We are now back to the model select screen, back out of it with the **Exit** icon.

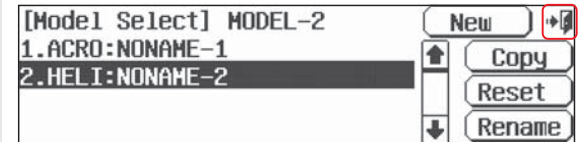

19. Back to the system menu page and one more time, press the **Exit** icon.

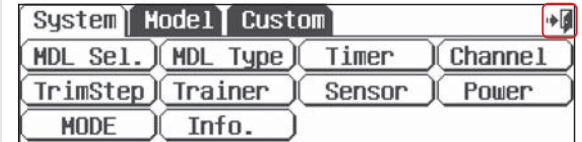

20. Here at the home page take little break, turn off the transmitter and prepare your model to be set-up.

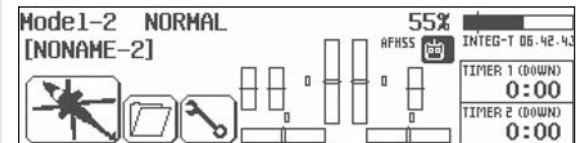

Model Menu Programming

21. Now turn on the transmitter, select **Yes** to transmit.

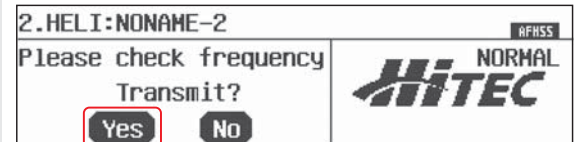

Throttle Lock

The Aurora features a "throttle lock" function that can be activated when the transmitter is transmitting a signal. We encourage you to apply the throttle lock as a safety precaution against "accidental throttle application".



Tip

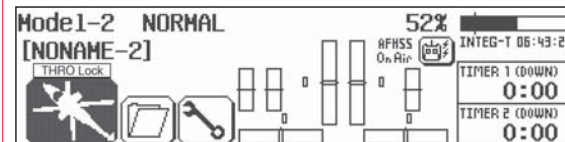

a. Turn the throttle lock on and off from the home page by pressing the **Model** icon for two seconds. Throttle lock is confirmed when the "THRO Lock" icon is displayed.

Model Menu Programming

22. At the home page, let's select some model functions by pressing the **heli** icon at the lower left of the screen.

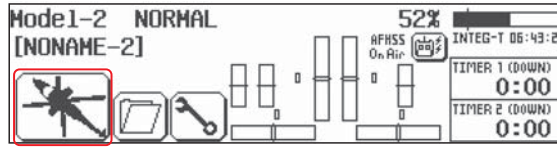

23. The Model menu is one of those "two page" screens, note the **1/2** icon. Here are all the functions the Aurora can apply to our rather simple selected model.

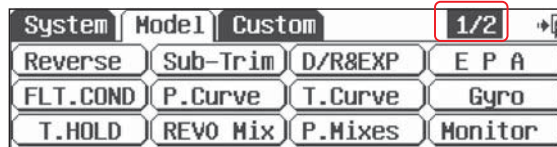

Now turn on power to your model. Within a moment, you should have control over your model with the transmitter.



If any of your models controls bind and stall the servo, turn off the model and correct the situation. Take the control horns off and reposition them with the model turned back on, then adjust the linkage accordingly.

We are going to use the following functions to set-up our model:

- Reverse** To correct any servo travel direction issues
- Sub-Trim** To trim-out any small control surface deflection issues
- EPA** This will set an end point to the servos throw in both directions
- Gyro** Program the gyro sensitivity and other functions
- Pitch Curve** Fine tune the collective curve for the best performance
- Throttle Curve** Fine tune the throttle curve for the best performance
- D/R&EXP** Set a dual rate and/or exponential function



Sure there are many more functions you may wish to try, but for our example please follow along and do the ones we suggest for your first model set-up.

24. Select **Reverse** from the model menu

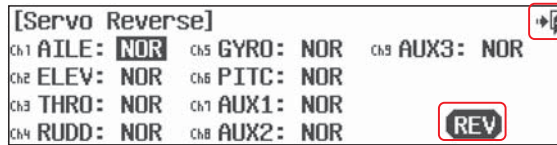

- a. Move your controls, are all the servos going in the correct direction? If not, select the channel to reverse, then press the **REV** icon.
- b. Press **Yes** when asked "Sure?"
- c. Do this until all servo throws are correct.
- d. Back up to the model menu by selecting the **Exit** icon.

Model Menu Programming

25. Select **Sub-Trim** from the model menu



Generally with a few exceptions, most notably the collective servo in a "normal" curve, and the throttle servo in a glow or gas aircraft, your servo control arms should be as close to 90 degrees as possible, and the control surfaces as close to level as you can make them by adjusting the control linkages. Sometimes small adjustment must be made to "center" the control surface using the sub-trim function.

- a. Select the control/channel to adjust by pressing the appropriate icon.
- b. Using the **+ RST -** icon at the screens lower right corner, adjust a value as necessary by selecting the plus or minus icon. Select **RST** to bring the value back to zero if you wish. You should see the control surface moving as changes are made with the **+ or -** icon.



Sub trim is not the place to do a major adjustment. Any servo needing more than 40 points of movement should be adjusted by moving the control horn or adjusting the linkage.

- c. Follow this procedure for any channels requiring sub-trim.
- d. When done, back up to the Model menu by selecting the **Exit** icon.

26. Select **EPA** from the model menu

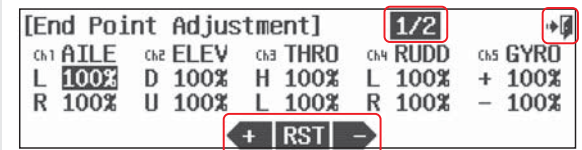

EPA stands for "end point adjustment". With the EPA function you can set the servo arm travel distance by lengthening or limiting how far the arm moves. This function can help avoid binding or damaging your heli control surfaces, if set up properly.

In our example we will adjust the channel six, pitch function to help you set-up your collective end points.



When making the following fundamental adjustments, the blades should be on the heli, and a pitch adjustment device showing the degrees of blade pitch should be used to set the collective end points correctly according to the heli manufacturer's specs. Be sure to disconnect the motor on electric helis to avoid injury.

- a. Press the **1/2** icon to access page two of the EPA adjustment menu.
- b. Move the throttle up and down to see the highlighted H and L value change. With the stick at full throttle, (all the up) we want full (up) collective movement. The H 100% should be highlighted.



It is at this point it may become clear that your collective linkages may need to be physically adjusted to achieve the heli manufacturer's negative and positive blade pitch specifications.

- c. Using the **+ RST -** icon set an appropriate value, more than 100% to increase the travel, or less than 100% to decrease the servo arm travel.
- d. Now move the throttle stick all the way down to the low throttle/low collective point and set the value for low collective.
- e. Repeat these steps for all the channels you wish to set an EPA value for.

Model Menu Programming



EPA is a handy function to adjust the high and low throttle linkage points on glow helis.

f. When done, back up to the model menu by selecting the **Exit** icon.

27. Gyro Functions

Because there are so many types of gyros and gyro functions, we must refer you to the complete description of the Auroras heli gyro functionality on page 84. Come back here when you are done with the gyro function.

28. Pitch Curve and Throttle Curve Adjustments

Ok, setting pitch and throttle curve points to maximize your helis performance can be a lengthy process requiring time, patience and some experience.

The good news is a pre-set linier curve is already programmed into the radio and you may not need to adjust the curves to fly your heli successfully.

If you need or want to adjust either the pitch or throttle curve, we direct you now to pages 73 through 74 to learn how to manipulate these curves.

29. Select the D/R&EXP from the model menu

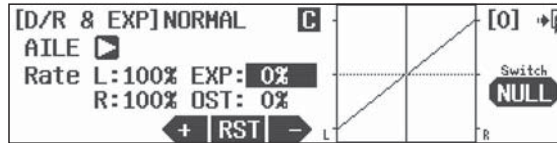

This screen holds both the dual rates and exponential rate menus.

Using Exponential Rates

Using exponential rates allows you to shape the normally linier movement of a control surface. Our goal is to soften the middle of the stick around the center point of the cyclic, your aileron or "roll" and elevator or "pitch" functions. You will see this curve shaped on the graph displayed on the screen. Using negative expo values will help any pilot fly smoother, with greater control over their aircraft.

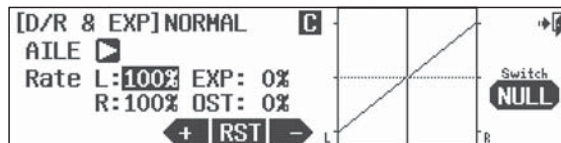

a. Touch the **EXP 0%** icon to activate it.

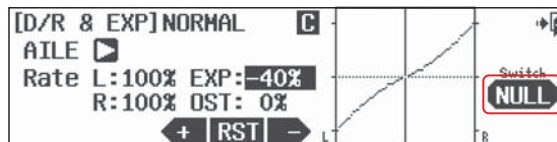

b. Now press **-** to apply a -40% value. See how the curve of the aileron or "roll" cyclic servos movement changes to "soften" the center of the aileron control sticks travel.
c. Press the **NULL** icon to select the switch for our roll cyclic expo rate function.

Model Menu Programming

30. At the intermediary switch screen press the **SEL.** icon.



31. This is a map of the Aurora switch layout. You can put the AILE expo select switch on any of the switches shown. then press **Exit** icon.

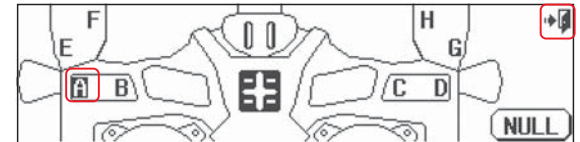

a. Let's select switch "A".
b. Select the **Exit** icon twice to back out.

32. Back at the D/R&EXP screen

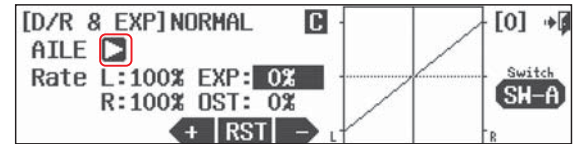

a. Change to the elevator or "pitch" cyclic servo by pressing the **arrow** to the right of AILE.
b. Now program our -40% EXPO value for the elevator or "pitch" cyclic.
c. Press the **NULL** icon to select the switch for our dual rate function.
d. Repeat steps 30 and 31 to place the function select on switch A.
Make sure your switch position is correct before entering a rate value.

What you should have is the ability to select full cyclic expo on or off with the A switch.



For more advanced users, different expo and D/R values can be applied under different flight conditions.

Your heli should now be ready to fly. Do a range check and pre-flight, then go have fun!

This is the end of the heli quick set-up guide. It will not be the end of your Aurora heli programming education. What you know is the bare minimum of the Aurora heli programming, just enough to get you in the air. We suggest you study the following:

- Pitch and throttle curves
- Throttle Hold
- Flight Conditions for Idle-Up modes
- FailSafe

- Page 73-74
- Page 126
- Page 116
- Page 19 for 2.4 and page 83 for QPCM.

System Menu

There are two primary menus in the Aurora programming. The System function menu and the Model function menu. The first we will explore is the System menu.



If you have not already programmed a model with the preceding quick start guide, we encourage you to do so before tackling the System and Model programming sections of the manual.

The following features are described in the system menu.

<p>Model Select menu</p> <p>MDL Type</p> <p>Timer</p> <p>Modulation</p> <p>TrimStep</p> <p>Trainer</p> <p>Power</p> <p>MODE</p> <p>Info</p> <p>Channel</p> <p>Freq Sel</p> <p>Sensor</p> <p>FailSafe</p>	<p>Create a new model</p> <p>Select an existing model</p> <p>Copy one models data into a new model memory slot</p> <p>Reset the model memory to factory default settings</p> <p>Rename a model</p> <p>Model type menu, ACRO, GLID or HELI.</p> <p>Menu for Timer 1, 2 and the Integral timer.</p> <p>Select desired modulation type, 2.4, 72 FM or QPCM.</p> <p>Size adjustment menu for the trim steps.</p> <p>Trainer option menu.</p> <p>Transmitter power adjustment menu.</p> <p>Stick mode option menu.</p> <p>Transmitter ID information.</p> <p>Model control channel assignment menu.</p> <p>Select the active models transmit channel while in PPM and QPCM only.</p> <p>Telemetry menu appearing while in 2.4GHz mode only.</p> <p>Appears in QPCM mode only. Used to set-up QPCM failsafe feature.</p>
---	--

1. Turn on the transmitter.

2. You are asked if you wish the radio to transmit a signal, press **No** for now.

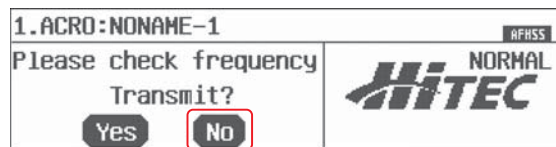

If you want to transmit, at any point in the programming process, turn off the transmitter and then turn it back on, you will be asked in the first screen if you wish to transmit, then press **Yes**.

3. To access the system menu from the home screen select the **wrench** icon.

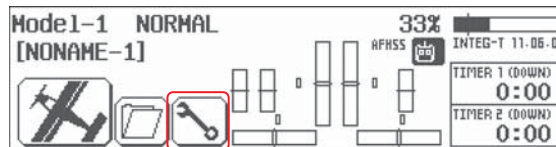

System Menu

These are all the features of the system menu associated with the active model. Full explanations of their function can be found in the following text.



Depending on the signal modulation is being used, the home screen will have slightly different functions.

Model Select Menu

From the MDL Sel. menu you can:

1. Create a new model.
2. Select an existing model to use.
3. Copy one models data into a fresh model memory slot.
4. Reset the model memory to factory default settings.
5. Rename a model.

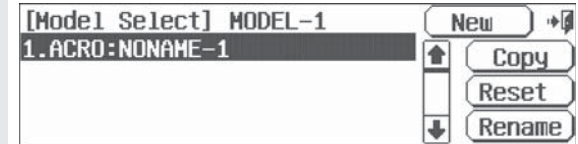

1. Create a new model

This function is one of the longest to explain and also one of the most exciting to perform as this menu provides the "base" for all future programming for the selected model.

Because this menu branches out in so many directions depending on the airframe choices you will select for your model, we want to print it just once. Please read and follow the Quick Set-up guide for either heli or airplane/glider and follow the directions there. After you have done this once, the menu will be "laid out" in front of you in a way so that it is almost impossible to make a mistake.

To reference the different airframe choices, see the Model Type menu description on page 49.

2. Select an existing model

- a. Use the scroll bar to find the model you wish to load and press the **model name**.
- b. Press **Select**.

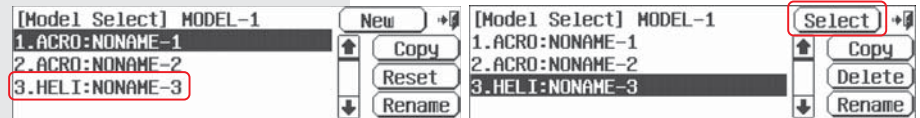

c. You are asked to ok the change, by pressing **Yes** or **No**, press **Yes**.

d. You are asked to confirm the transmit channel on 72MHz. This screen will not appear if 2.4 is used. (Screen not shown)

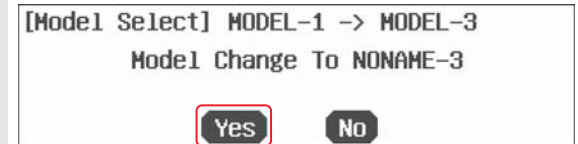

e. Next when directed to the transmit Yes - No screen, press **No**. We don't need to transmit yet. Now we are back to the home screen.

Model Select Menu

3. Copy one models data into a new model memory slot

- a. From the System menu select **MDL Sel.**
- b. Select the model you wish to copy from the list of models on the left. select, **Copy**.
- c. Press, **New**.

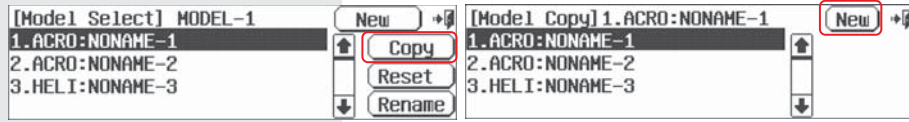

- e. You are asked, if you wish the selected model to be copied to the next free model memory slot. Press, **Yes**. Note the next memory slot has the same name and programming as the selected model. You may want to change the model name using step 5, the model "rename" feature in this section.
- f. Press the **Exit** when you are done.

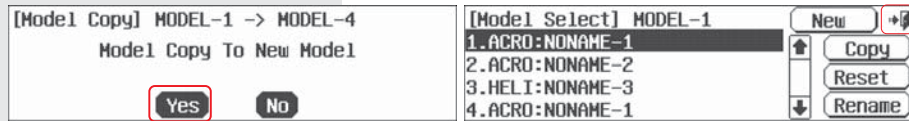

4. Reset the active model memory slot to factory default settings

- a. From the system menu select **MDL Sel.**
- b. Select the model you wish to delete from the list of models on the left.
- c. Press **Delete**.

- d. Press **Yes** to confirm the deletion of the active models programming.

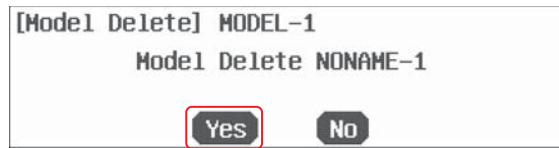

- e. Now we are back at the model select menu, press the **Exit** to enter the system menu.



5. Rename a model

- a. From the system menu select **MDL Sel.**
- b. **Select** the model you wish to **rename** from the list of models on the left.

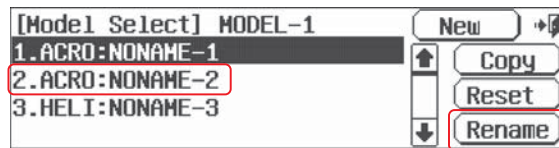

- c. Rename it using the keyboard screen, when done press, **Enter**.



- d. Now back at the model select screen, press the **Exit** icon to return to the system menu.

Model type Menu

The model type screen defines the features of the active model. These are the features we told the radio our model had during the "create a new model" process plus all the default features. Here we define all the choices you have while setting-up your aircraft in the Aurora.

There are three types of aircraft "model type" menus,

ACRO		For all fixed wing, glow, gas and some electric powered models.
GLID		For all pure gliders and some electric powered airframes.
HELI		All helicopters will use the HELI menu.

We will first define ACRO;

Model Type ACRO Menu Programming

- a. From the System menu select **MDL Type**.
- b. Press the **Model** icon on the left.



- c. Select **ACRO**.
- d. Confirm the change to ACRO, press **Yes**.

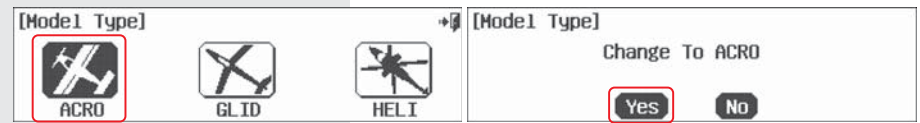

- e. There are two screens of wing type choices. Press the **1/2** icon to see the second screen of wing types.
- f. The wing type menu contains these choices. Select the choice for your airframe and press, **SET**.

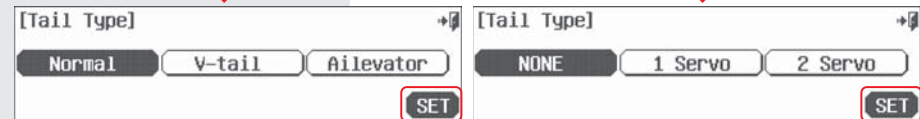
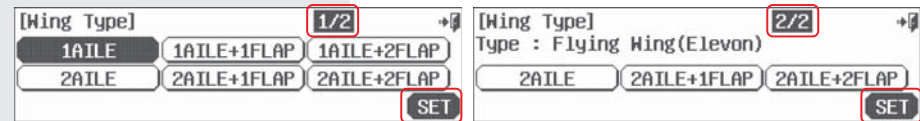

- g. Select your airframe tail type icon
- h. Press **SET**.

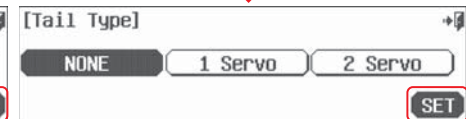
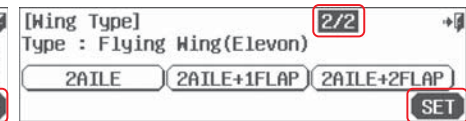

- g. Select your flying wing tail type icon
- h. Press **SET**.

Model type Menu

i. Select the **Single** or **Dual** engine icon.
j. Press **SET**.



k. Does your model have retracts?
Press **Yes** or **No**.



Note If you select, **Yes** to the retract question, "Gear" will be associated with a channel shown in the channel function menu described in detail on page 56, and shown to you later in this process in step n. You will have to associate a control or switch to the "Gear" function. The method to do this is found in the channel function menu on page 56.

l. Does your model have airbrakes?
Press **Yes** or **No**.

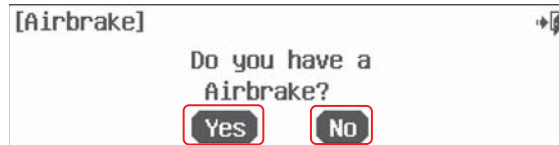

m. Does your model have a fuel mixture control?
Press **Yes** or **No**.



n. This is the Channel Function menu.
It shows you what transmitter controls operate the different aircraft controls. For a detailed description on this menu, refer to page 56.
For now, press **Yes**.



o. Press the **Exit** icon to return to the model type menu screen.



This is the end of the acro model type menu. For a complete description of the glid and heli model type menu, refer to the following sections.

Model type Menu

This is the model type menu for most gliders and some electric airplane applications.

Model Type GLID Menu Programming

a. From the System menu select **MDL Type**.
b. Press the **Model** icon on the left.



c. Select **GLID**.
d. Confirm the change to GLID, press **Yes**.

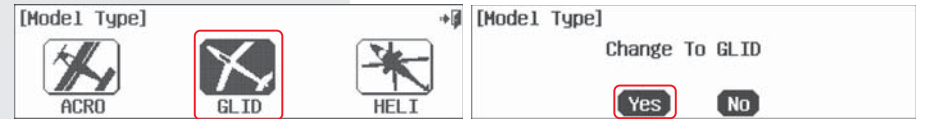

e. There are two screens of wing type choices. Press the **1/2** icon to see the second screen of wing types.
f. The wing type menu contains these choices. Select the choice for your airframe and press, **SET**.

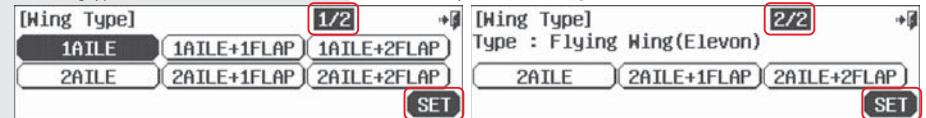

g. Select your airframe tail type icon.
h. Press **SET**.

g. Select your flying wing tail type icon.
h. Press **SET**.

i. Select **Yes** if you need a motor control channel function.

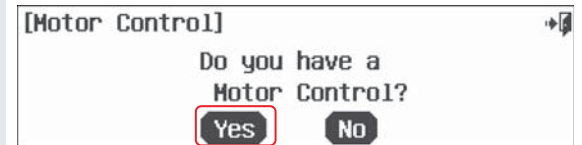

j. Does your model have retracts?
Press **Yes** or **No**.

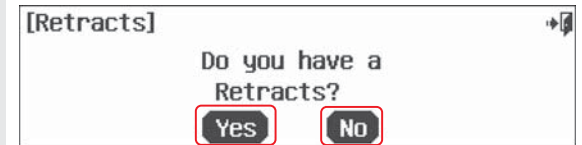

Model type Menu

k. Does your model have airbrakes?
Press **Yes** or **No**.

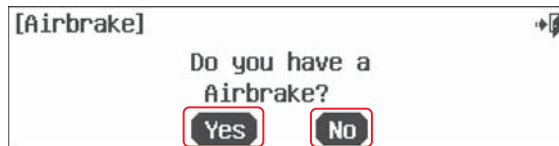

l. This is the Channel Function Menu.
It shows you what transmitter controls operate the different aircraft controls. For a detailed description on this menu, refer to page 56. For now, press **Yes**.

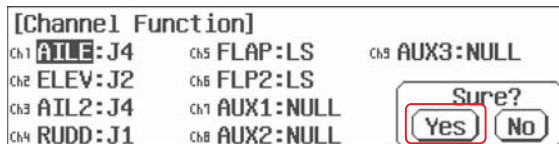

m. Press the **Exit** icon twice, to return to the model type menu screen.



Model Type HELI  **Menu Programming**

Use the following information to set up your heli features in the model type menu.

a. Press the **Model** icon.

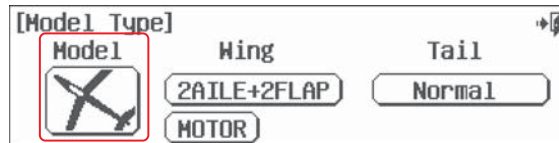

b. Select **HELI**.



c. Confirm the change to HELI, Press **Yes**.



Model type Menu

d. There are two screens of swash type choices. Press the **1/2** icon to see the second screen of options.

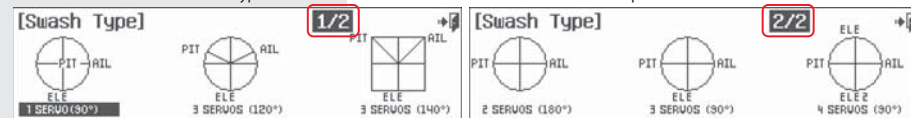

e. The swash type menu contains these choices. Press the choice for your heli.

f. Does your heli have a Governor?
Select **Yes** or **No**.

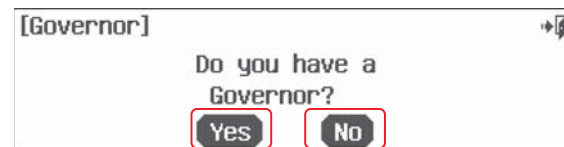

g. Does your model have a needle control?
Press **Yes** or **No**.

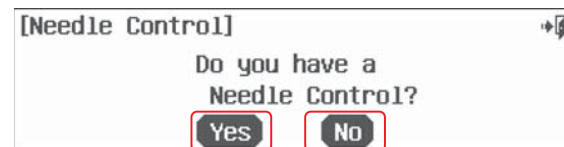

h. Does your model have a fuel mixture control?
Press **Yes** or **No**.

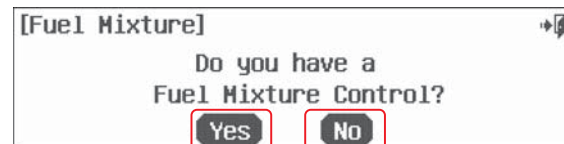

i. This is the Channel Function Menu.
It shows you what transmitter controls operate the different aircraft controls. For a detailed description on this menu, refer to page 56. For now, press **Yes**.



j. Press the **Exit** icon twice, to return to the model type menu screen.



Timer Menu

The Aurora features three timers, an integral or “total time on” timer, the “timer 1” and “timer 2”. We will first show the timer 1 and timer 2 menus, then lastly discuss the integral timer.

Timer 1 and Timer 2 Set-up

- You choose to activate timer 1 and/or timer 2.
- Select the time value.
- Select a “count up” or “count down” format.
- Select the timer 1 and timer 2 activation switch.

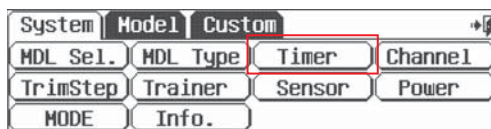

- Access the timer menu from the system menu **Timer**, or Press the timer 1 or timer 2 icon on the home page.
- Press **ACT** to activate the timer function.



- Press **0:00** to set the time value with the up/down **RST** icons.
- The default counting mode is DOWN, select UP if you want this changed to UP.

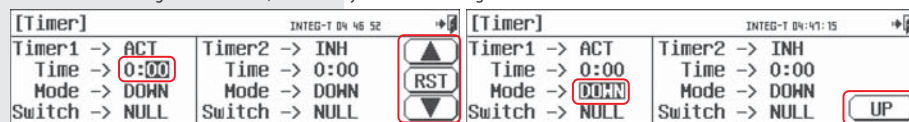

- Select the **NULL** icon to transfer the timer function to a switch, or the throttle.
- At the intermediary switch screen press the **SEL.** icon.

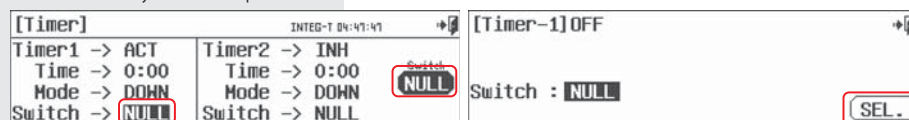

- This is a map of the Aurora switch layout. You can put the timer function on any of these switches, or the throttle.

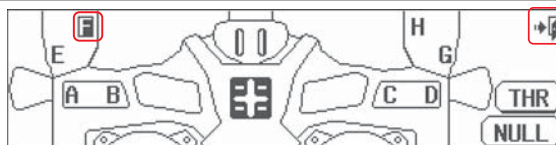

- We will show examples for doing both.
- Let's select switch "F".
- Select the **Exit** icon to “back” out of this screen.



- Some switches are two, and some are three position switches.
- Switch H is a “dead man” toggle switch that is primarily used for training and/or throttle cut purposes.

- Flip switch **F** back and forth, note the switch icon changing. Depending on your preference you can select the “up” position or the “down” position to be on or off.



Timer Menu

- Flip switch **F** towards you. The lower position of the icon should be highlighted. Press the **OFF** icon.
- Now press the **ON** icon.
- Your timer is now active when the switch **F** is toggled toward you.
- Back out, by pressing the **Exit** icon.

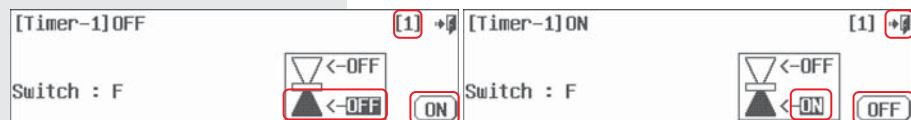

To select the throttle as Timer 2's activation trigger

- Follow steps a-f in this section, to activate timer 2.

- At the switch menu, select the **THR** icon

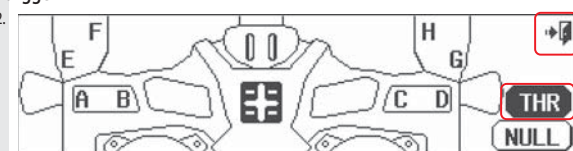

- Press the **Exit** to back out.

- Press the top **OFF** icon in the little box.



- Press the **ON** icon.

- Press the **0%** icon.



- Move the throttle stick to the position you want the timer to start. We suggest a position just above idle. Note the bar move up and down the vertical graph, press **SET**.

We now have selected the throttle to activate the #2 timer when the throttle is “up”. When the throttle is back at idle, the timer is not running.

The Integral Timer

Located on the home page, the integral timer displays the “total time on”.

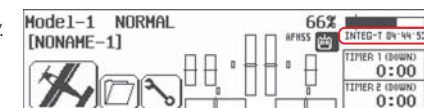

To reset the integral timer back to 00:00:00

- Select the **Timer** icon from the system menu.
- Press the **INTEG-T XX:XX:XX** “time” icon at the upper right of the screen
- Select **RST** to reset the Integral timer to zero.
- Press the **Exit** to return to the system menu.



Channel Menu

This screen displays the controls associated with their respective channels. Here are all the control functions. Using the channel select functions allow a high level of creativity in the way you can custom program the Aurora.

For our example we will add the Fuel-Mix control to channel 9.

a. Select the **Channel** icon from the system menu.

b. Press the function (should be, **AUX5**) to the right of ch. 9.

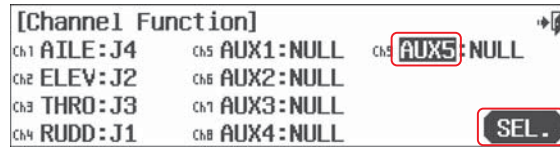

c. Press, **SEL.**

d. Press **Fuel-Mix.**

e. Press **SET.**

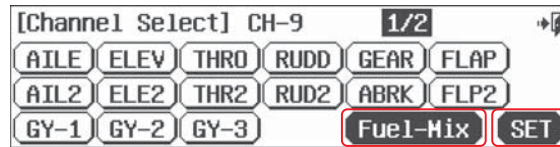

This menu has two screens. Note the **1/2** icon, press it to see screen two.

f. Back at the Channel Function screen, press the NULL icon at ch. 9 Fuel : **NULL**

g. Press, **SEL.**

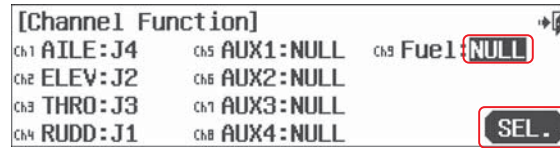

h. Select a controller for the Fuel-Mix function, perhaps the throttle, or J3 stick is used to richen or lean the fuel mixture as the throttle is moved? Press **J3.**

i. Press, **SET.**

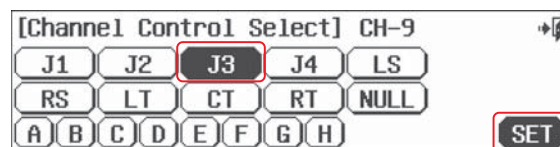

j. Touch the **Exit** icon to go back to the system menu.

This level of choice defines the Auroras “open” software architecture. Experiment to find what you can do here, as there is no “right” or “wrong” way to do it.

Modulation Menu

The modulation menu allows you to select which of the three signal types you want to use. This menu does not appear when the 2.4GHz module is installed.

PPM/N or /P for 72MHz FM negative or positive shift or Hitec QPCM receivers.



The Aurora knows what modulation type module is installed and will default to that specific format.

Changing from 2.4GHz to 72MHz. PPM Negative, Positive shift or QPCM signal



If you are changing the modulation to 72MHz FM, you must tell the radio if the PPM receiver you are using is Positive or Negative shift.

- Hitec builds both Negative and Positive shift receivers. Look on the label for the proper application.
- Futaba® receivers are Negative shift
- JR® receivers are Positive shift.
- Airtronics® receivers are Positive shift.
- Multiplex® receivers are Positive shift.

a. Remove the SPECTRA 2.4 module and replace with the SPECTRA PRO 72MHz module.

b. Remove the 2.4 antenna and replace with the 72MHz antenna.

c. Turn on transmitter.

d. Press **No** when asked to transmit.

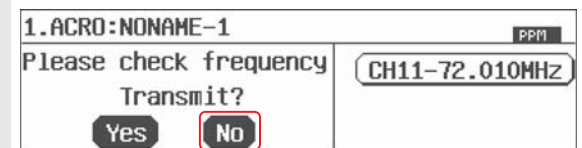

e. Press the **System menu** icon.

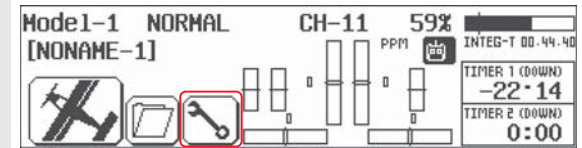

f. Select **Modulat** from the system menu.



g. Select **PPM/N** if you are flying a negative shift receiver.

h. Select **PPM/P** if you are flying a positive shift receiver.

i. Select **QPCM** if using a QPCM receiver.

Modulation Menu

j. Here you are asked to confirm the modulation change to whatever you selected. Our example is PPM/N.

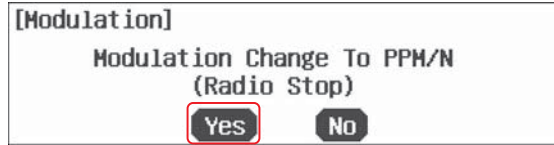

k. Press **Yes** when you are satisfied with your 72MHz signal shift choice.

l. Press the frequency channel number icon on the right of the screen to set the channel you want to transmit on.

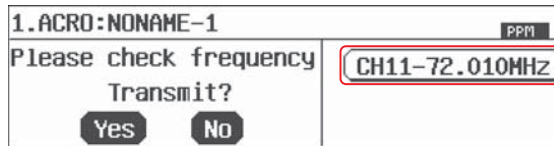

m. Press the 1/2 icon at the upper right of the screen to move to the next group of frequency channel choices.

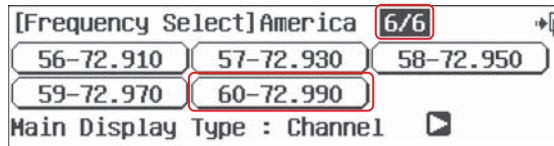

n. Select the channel you want by pressing the icon associated with it.

o. Review the frequency is correct and press **Yes**. The Aurora should confirm it is transmitting on the home screen with the "on air" icon.

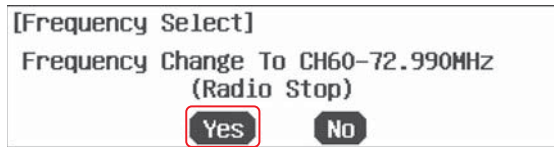

p. Perform a range check and go fly!

To change from 72MGz to 2.4GHz

- a. Remove the 72MGz antenna and replace with the lower half of the 2.4 antenna.
- b. Remove the SPECTRA 2 module and replace with the SPECTRA 2.4 module.
- c. Attach the upper antenna.
- d. Turn on transmitter.

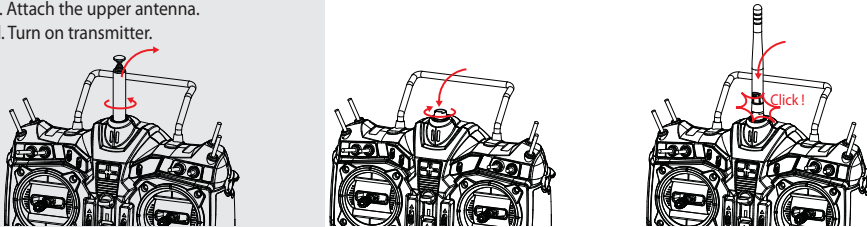

e. Press **Yes** to transmit.

f. You are now back at the home screen with the Aurora transmitting the 2.4GHz signal.

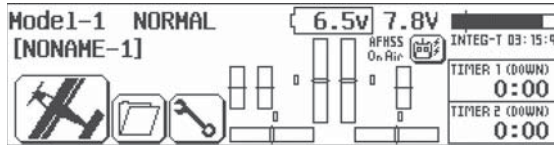

TrimStep

At the Trim Step screen we can change the size of each step the digital trims move with one "beep", or "movement step value" of a digital switch.

a. Press the **TrimStep** icon from the system menu.



b. To increase or decrease the size of the trim step, press the **number** value to the right of the trim you wish to change.



c. Change the value with the **+ RST -** icon.

d. Exit when done by selecting the **Exit** icon.



The Trim Step value can be selected from 1 to 200. The default is 12.

Trainer Menu

The Aurora can be used to help teach students how to fly with a variety different features defined in the following section. Among the trainer features will be;

- Allowing complete, or partial control to the student by selecting what controls to allow the student to use.
- Use the mix feature to let the student have a percentage of the control throw, and the master uses the rest!

The Aurora is compatible with all other Hitec transmitter products using the 3.2mm stereo plug or the DINN connector plug.



When using transmitters in the trainer mode;

- The master radio must be programmed with the model to be flown.
- The slave, or student transmitter must have the proper servo reverse and trim settings to match the master transmitter. Check this all before take-off.
- It is best to remove the module or frequency transmit crystal from the student transmitter.

To use the Aurora as a "Master" radio, setting the trainer switch and other features.

a. Select **Trainer** from the system menu

b. Press **ACT** to access the trainer menu



c. Select a switch for the trainer function. At this point. Press **NULL**.

d. Press **SEL**.

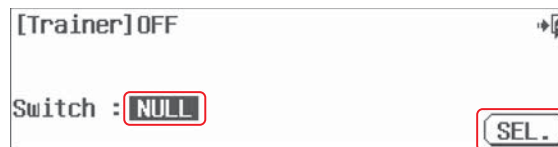

e. Select the "dead man" switch **H**
f. Press the **Exit** icon and return to the trainer switch menu screen

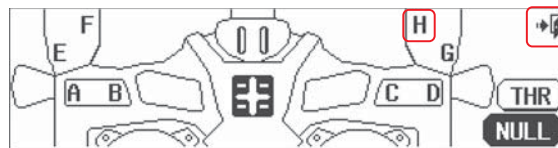

g. Press the lower **OFF** icon

h. Press the **On** icon, toggle the H switch on and off to activate the student transmitter or return control to the master Aurora.

i. Press the **Exit** and return to the trainer menu screen



Trainer Menu

j. To further manipulate the trainer function, press the **MODE: ALL** arrow.

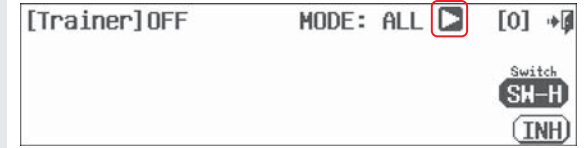

k. Here we can choose to limit the controls the student has access too by selecting the lower part of the column with the **OFF** icon.

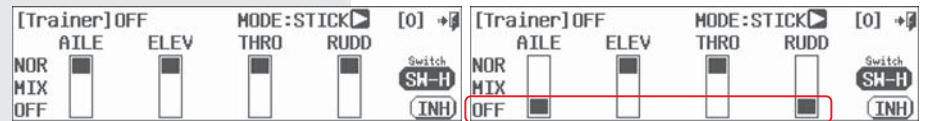

l. Another option is to limit the "rate" the student can move an individual control with the **MIX** feature. Select the center of the column to choose a "mix" between the master and student transmitter.

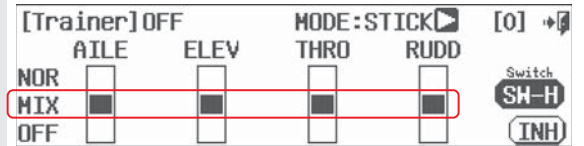

m. Next, press the **SW-H** switch icon to enter the switch menu to set the Mix rate.



n. Press the 100% Mix Rate icon and apply a **50%** rate value with the **up** and **down** arrow icons. The result of this will be;



o. When the **H** switch is active, the master radio will still have 50% of the control capability, even when the trainer switch is pulled. At the same time, the students access to all the flight controls remain at a 50% rate value. This is like an "automatic dual rate" for the student and an "instant override" for the instructor.

Power Menu

The Power menu allows you to choose;

- Backlight time on options.
- Automatic turn-off function, in case you accidentally leave the transmitter on.
- Battery type menu.

a. From the system menu, select **Power**.

b. From here you can select the backlight options. Cycle through this menu by pressing the **arrow** key.

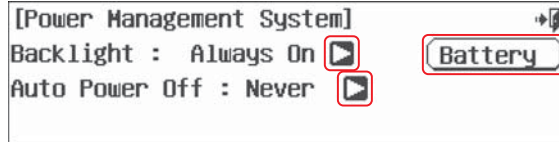

c. Cycle through the "Auto Power Off" menu as to view the choices here.

d. Press the **Battery** icon to enter the battery choice menu.

Change to a Li-Po battery, the Li-Po Option

The nominal voltage of a two cell Li-Po or Lithium Polymer battery pack is 7.4V. The user has the option to power the Aurora with a 2S formatted Li-Po but accepts full responsibility to do so safely. To use a Li-Po transmitter battery safely, you must remove the battery from the transmitter case for charging, and reinstall it after charging.



DO NOT install a Li-po in the Aurora, and then try and charge it with the supplied CG-545 charger. The CG-545 was created for NiMH cells only! Certain major damage is sure to occur.

Change the battery choice from Ni-Cd or Ni-MH to Li-Po.

a. At the battery screen, press the **arrow** key.

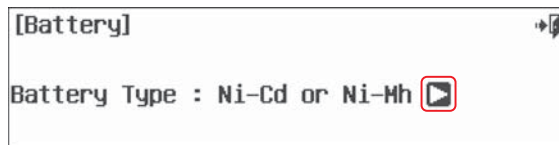

The default is for a 7.2V Ni-Cd or Ni-MH.

b. You are asked to change to Li-Po, select **Yes**.



c. Here you can modify the transmitter alarm voltage from 6.0V to 6.5V in 0.1V steps with the **+RST-** icon.



d. When done, press the **Exit** icon.



Many Li-Po manufacturers don't recommend drawing the voltage of a cell below 3 volts. A two cell Aurora li-po battery pack should not spend much time at, and below 6 volts.

MODE Menu

The mode, or "stick" mode menu lets you easily select what mode you wish to use.

The Aurora supports Mode 1, 2, 3, 4 and two custom modes. In America, stick mode 2 is the most popular with at least 95% preferring it. Followed by stick mode 1 users and a fractional number preferring modes 3 and 4.



Mode 2 is the factory default setup for the Aurora 9 in US market.

1. To change the stick mode, select the appropriate icon at the stick mode screen.

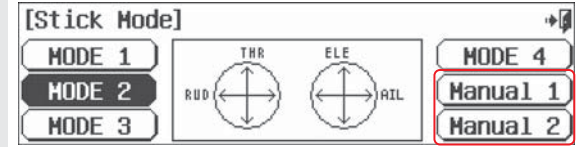

2. If you want to make your own custom stick mode, select the **manual 1** or **manual 2** icon.

1. Identify the controller J1, J2 etc...by pressing it, and then press the corresponding function to link it to the controller. Do this until done.

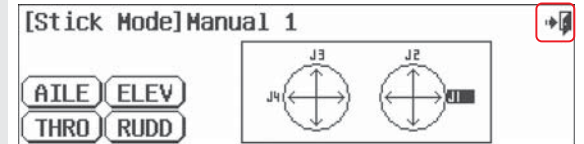

2. Press the **Exit** icon twice to back out to the System menu.

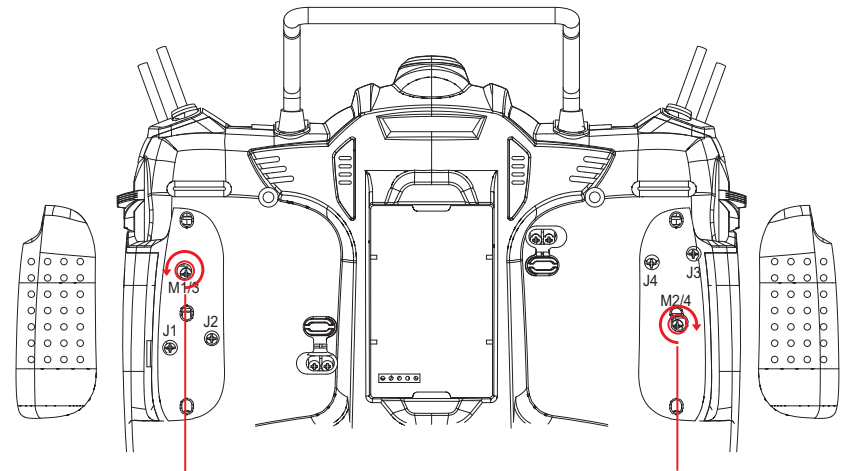

For the hardware Mode Change, a Philips(+) driver is required.
For Mode 1 to Mode 2 change turn the screws as shown above.

To reference the ratchet adjustments necessary to change from the mode 2 format to another mode refer to page 26

Info Screen

The Info screen contains the following information about your Aurora.

- Program your name into the Aurora with the "User Name" feature.
- Current Aurora software version.
- The "Area", defining what frequency bandwidth will appear in the Aurora programming.
For the U.S.A., it will be the 72MHz and AFHSS 2.4 choices.
- Unique Aurora "Product ID Number".

To add your name to the Aurora;

- From the system menu, select **Info**.
- Press the **Rename** icon.

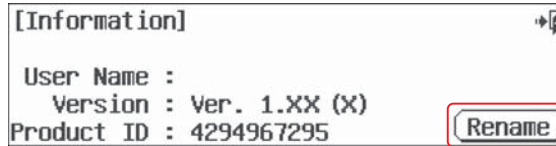

- Type in your name at the user name menu.
- Press **Enter** when done.



- Press the **Exit** to back out to the system menu.

Freq Select Menu

When in the PPM or QPCM modulation modes, the SPECTRA PRO frequency synthesizer allows you to choose what 72MHz FM channel you want to transmit on for the active model. This screen will not appear in AFHSS 2.4 mode.

- From the system menu select Freq Sel.
- See the 1/6 icon? This tells you there is more than one screen to this menu. Press the 1/6 icon to access page 2. Each time the fraction icon is touched, another page is displayed.
- Press the fraction until you reach page 6.

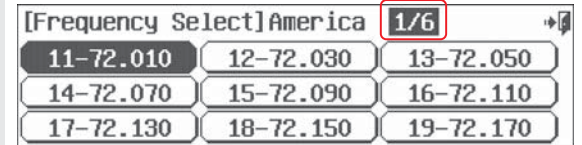

- On page 6 there is a choice on how you want the default frequency display to appear on the home screen. We encourage you to have it read, Channel. Press the frequency arrow icon to select; Channel

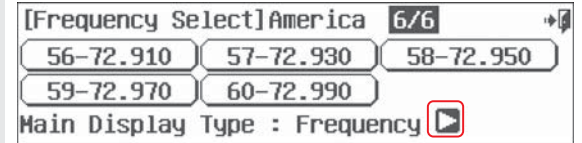

- Return to the page containing the channel you wish to select for the active model. Press the icon for the channel number of the receiver in your aircraft.

- Press, **Yes** to confirm the frequency change.

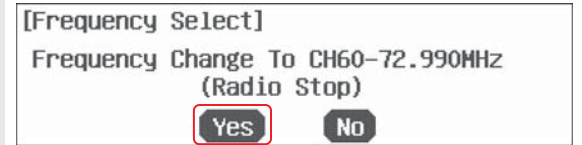

- Now at the transmit screen, (screen not shown) select Yes if you wish to transmit or No to "not" transmit. Both selections take you to the home screen.

Sensor

The Hitec AHFSS 2.4GHz technology supports the use of onboard sensors.

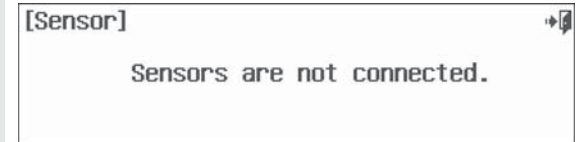

Sensor Station and its related sensors are planned for the Aurora in near future. Please visit the Hitec website at www.hitecrd.com for information on the availability of these accessories.

Model Menu and More... Major Super Special Hints

This section contains the following information;

IMPORTANT PROGRAMMING TIPS

Additional menus.

- Custom and Adjustment features
- Adjustment menu
- Selecting a switch
- The adjust function switch set-up
- Camber and Launch menus
- Helicopter throttle and pitch curve adjust function, hover trim & more...
- Trim link
 - Adjust to trim
 - T.APP
- Cut Postion
- Launch cut

The Switch selection process

Model menu features common to all model types (airplane, glider and heli)



Once again, we encourage using the quick start guide to program your first aircraft before you journey into the model menu functions. There are many basic, fundamental lessons to be learned in spending 20 minutes using the quick start guide. Doing so will certainly speed you through the Aurora learning curve.

***** IMPORTANT PROGRAMMING TIPS *****



Throttle Lock

During the set-up process, when the transmitter is transmitting to the aircraft so you can see what the effects of changing values are on the control surfaces, on the home page press the Model icon and hold it for two seconds. This action will start and stop the throttle lock.

Reset, the best hint of all

As you program a model into any computer radio, especially one as sophisticated as the Aurora, it is easy to make a mistake. If "things" just are not working the way they should, start over. There are thirty model memories in the Aurora. Start a new model or Reset the current one in the System-MDL Sel. menu. You will lose all the programming you have done for that model up to that point, but starting over is the best "cure" for 90% of all "problems" modelers have with programming issues.

With very complex models, it would be wise to "save" a programming sequence by periodically using the Copy option in the model select menu.

Switches

The functions that you program into the Aurora will be "on" all the time, noted as NULL on the specific features menu screen. All these features can be toggled on or off using a two position switch, or several different values can be applied to some features using three position switches. While still other functions like Camber are applied to a slider and their movement dialed-in as needed. All these different methods for selecting and formatting switches and other control functions are described on page 68 in the manual rather than being repeated throughout the document on every other page.

Flight Conditions

Arguably one of the most power features of the Aurora are the multitude of different options the Flight Condition feature can apply to the programming. As you travel the Aurora learning curve, we encourage you to explore how the flight conditions can influence almost every feature of the Aurora. Of major note will be the C (combined) and S (separate) options that deliver an almost infinite number of programming combinations.

Selecting a Servo or Channel to Adjust the Value

There are three ways to select a servo to adjust;

- Use the control stick to make the adjustment. Right and left, up and down to select the direction you want to adjust. This way you see the results of your input if the aircraft is turned on.
- Press the % value icon for any single servos one direction.
- Press the name icon of the control to be adjusted and adjust both directions at the same time.

Additional Menu, the Custom and Adjust Features

In addition to the system and model menu, there are two other menus that can appear and be used during the Aurora programming process.

Custom Menu

The Custom menu is created by the user during the programming of a model. The intent was to provide one menu screen holding up to 12 icons for the functions you use most for the active model.

- a. From the home screen press the Folder icon.

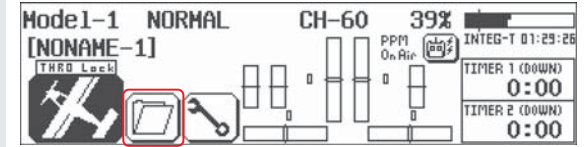

- b. Press the Custom tab and it will change to Edit.



- c. You can add model, and system menu features to the custom folder. We will select the model menu for our tutorial.
- d. Add feature icons to the custom menu by pressing their icons, say you adjust Aileron to Rudder and P-mixes often, touch their respective icons and highlight them.
- e. Press the Edit tab to save and exit.
- f. Press the Edit tab again, it changes to Custom tab.
- g. Now instead of fishing through all the different feature icons in the system and model menus, you can quickly access the features you use the most.
- h. To clear the Custom menu, press the custom tab and to Edit, the selectReset.

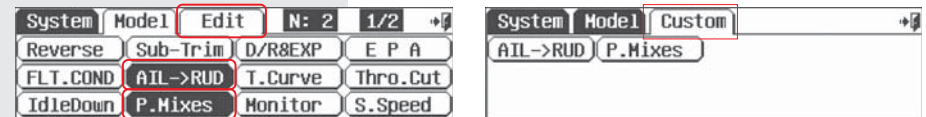

Adjustment Menu

Many of the Auroras features offer a switch selection process. One of the options presented in several of these features is to choose an "adjustment" switch. Most often this is VR switch LT, CT, RT or a slider, LS or RS.



If you have selected to adjust a function with the LT, CT, RT switches or a slider, you can access the adjustment screen quickly through the Adjust menu tab which appears automatically when the adjustment option is selected during the switch select process.



When more than one function is assigned to a VR switch, when the switch is toggled, the adjust menu appears so you can select the icon for the function you wish to adjust

Model Menu and More... The Switch Selection Process

Selecting a Switch

Many of the Aurora features can be placed on a switch to turn the feature on / off, or provide multiple values to a function like dual and exponential rates.

To avoid repeating the switch selection process throughout the manual, we are presenting it in its entirety in this section. Here you will learn to program the following Aurora switch features;

1. The NULL condition
2. Two and three position switch selection
3. Adjust function switch set-up
 - Camber and launch menus
 - Heli throttle and pitch curve adjust function
4. Trim link activation
 - Adjust to trim
 - T.APP, (trim link)
5. Cut Function set-up
 - Launch cut

1. The NULL condition

The functions that you program into the Aurora will be "on" all the time, noted as NULL on the specific features menu screen. Almost all of the Aurora programming functions can be toggled on or off, using a two position switch, or several different values can be applied to some functions using two and three position switches. While still other functions like Camber are applied to a slider and their movement dialed-in as needed.

The question you must answer almost every time you program an Aurora function will be;

"Do I want to place this function on a switch?"

Yes

If you want to turn the function on and off, or program multiple rate values, apply a switch to the function.

No

If you want the programmed feature to be "on" all the time, DO NOT apply a switch to the programmed function. Leave it in the NULL condition.

2. Two and three position switch selection

There are both two and three position switches on the Aurora. They are used to do two things, turn a function on and off or, each switch position can be a travel rate value on multiple rate value functions.

On and Off

Turn a function on or off, as when used with a switchable feature like aileron to rudder mix, the mix is either on and using the movement values you programmed for the aileron rudder mix, or the mix is turned off.

Multiple Rate Values

Other functions like dual rates allow you to use multiple movement rate values for different switch positions. For example, using a three position switch you can program a different "rate" of movement for each switch position.

Selecting a Switch

Two position on and off

We will use the aileron to rudder mix to set up a two position switch on or off function.

a. Select the AIL-RUD icon from the model menu.



b. Press ACT to access the mix menu screen.

c. Press the NULL icon.

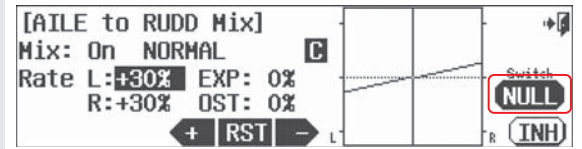

d. Press SEL.



e. Let's put our switch for the aileron to rudder mix on switch A. Press the A icon.

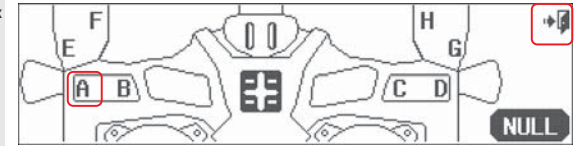

f. Press the Exit to return to the AILE to RUDD mix switch screen.

g. Press the ON icon.

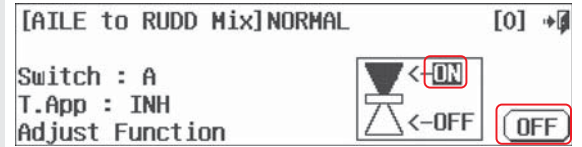

h. Press the OFF icon in the corner of the screen.

i. Select the lower OFF icon.

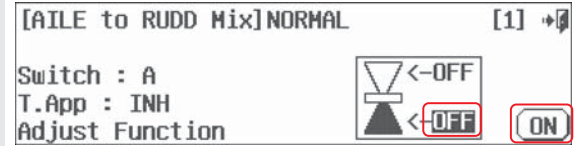

j. Press the ON icon.

k. Move switch A to see how the icons on the screen react to this movement. Note the switch position represented by the [0] and [1] icons.

Selecting a Switch

Three position switch multiple value set-up

For this example we will set three aileron movement value rates on a three position switch.



Follow this method to set multiple values on any two position switch.

a. Select **D/R & EXP** from the model menu.

b. Press **NULL**.

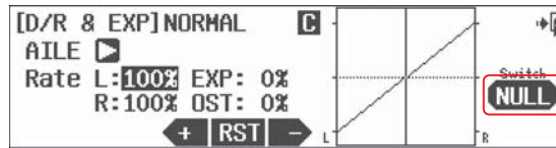

c. Press **SEL**.



d. For our example select the switch **C** icon.



e. Press the **Exit** to return to the D/R & EXP menu screen.



f. With switch **C** in the **[0]** position, (all the way back) press the **Rate** icon to highlight both aileron control directions.

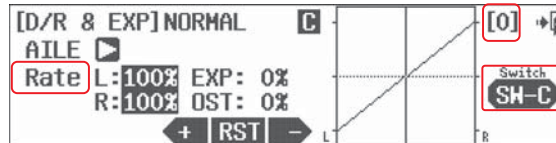

Selecting a Switch

g. Press the **+** icon to get a **125%** value for both the left and right aileron.



h. Move **switch C** to the **[2]** or (all the way towards you) position, bypassing the middle position.

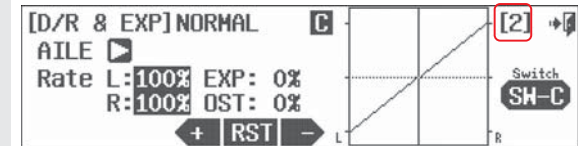

i. With the switch **C** in the **[2]** position, use the **-** icon to place a **75%** value for the aileron movement.

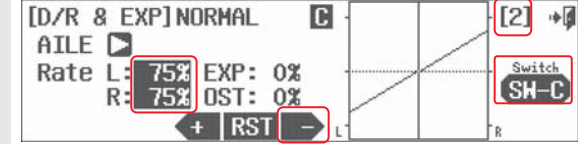

j. Now by moving switch **C**, we can choose a 125%, 100% or 75% movement rate for our ailerons.



Understand this is a simplified example. You can get as complicated as you find necessary to control your model to your satisfaction by using flight conditions in conjunction with the **C** and **S** feature.

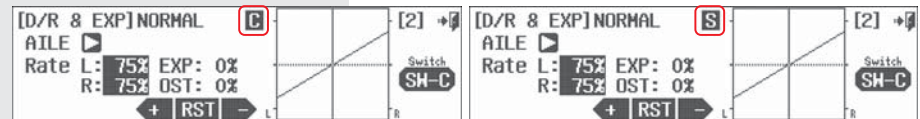

Press C to change it to S (Separately)

Press S to change it to C (Combination)

A more detailed explanation of the **C** and **S** functions can be found on page 90.

Adjust Function switch set-up

The adjustment feature was created to allow the fine tuning of a function like the aileron to rudder mix while the aircraft is flying. To show an example of this feature, we will return to the aileron-rudder mix switch screen.

a. Press **AIL -> RUD** from the Model menu

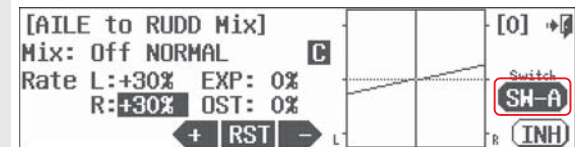

b. Press **SW-A** icon

Adjust Function switch set-up

c. Press the **Adjust Function** icon.

d. Select **SET**.

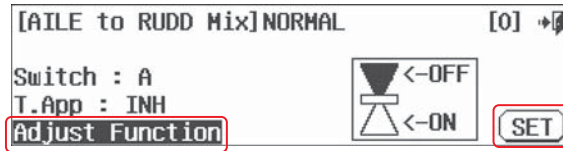

e. Press **SEL**.



f. Let's choose the **LT** switch to adjust the aileron to rudder mix.

g. Press the **Exit** icon to go back to the AILE to RUDD Mix Adjust screen.

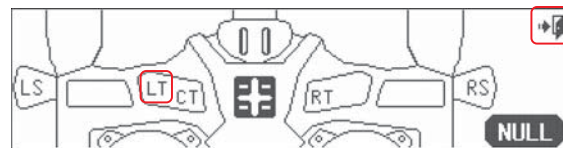

h. If we want to expand or contract the adjustment range the LT switch is capable of, press the **+RST-** icon and note the effects.

i. Press the **Exit** icon repeatedly until you have backed out to the home screen.



j. Use the **LT** switch and apply a value to the aileron to rudder mix. Note its effect on the model.

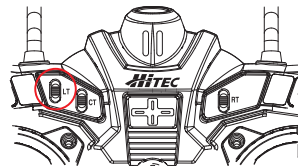

Additional camber and launch mode adjust function menu (GLID)

The Camber Mix and Launch features have several screens in the adjustment menu allowing you to set adjustment travel rate values for the control surfaces used in the Launch and Camber functions when the function is active. Select a control surface value to change, and change the value with the **+RST-** icon.

This is Camber mix screen 2/2.

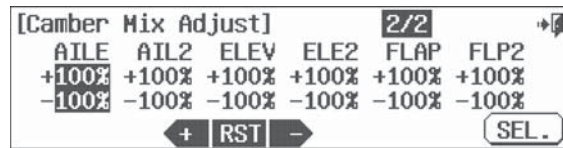

Additional camber and launch mode adjust function menu (GLID)

This is Launch mix screen 2/2.

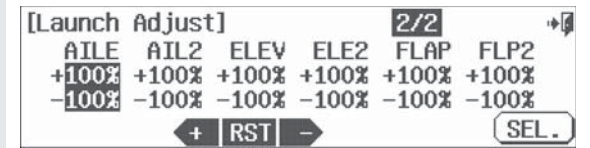

Helicopter throttle and pitch curve adjust functions, hover trim and more

The heli mode throttle and pitch curve adjustment menus offer several options for in-flight adjustment of hover throttle and pitch trim. The pitch curve also includes a high pitch adjust, and a low pitch adjust switch option.

In throttle curve adjust function menu choose to have;

- Throttle hover
- Throttle with pitch hover

In the pitch curve adjust function menu choose to have;

- Pitch hover
- Pitch curve high pitch adjust
- Pitch curve low pitch adjust



- Check out all the throttle and pitch curve adjust functions. Learning to use these features can dramatically improve the performance of your heli without the expense of hardware upgrades.
- Use them all, or select between them.

We will first describe the throttle hovering adjustment menu. All other throttle and pitch curve adjustment menus are identical in the way they are programmed, so as to avoid repetition in the manual text, we offer the adjust function process explanation just once.

Throttle and Pitch curve adjust function programming

We will use the throttle curve adjust screen one, hovering switch set-up for our example.

a. Press **ACT** icon to activate the feature

b. Enter the throttle curve switch menu by selecting **NULL** at the throttle curve menu screen.

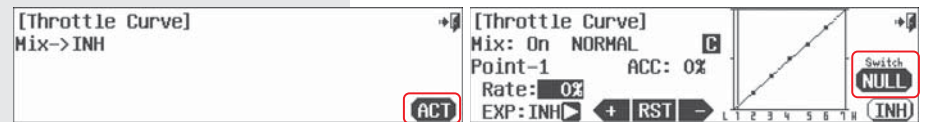

c. Press **Adjust Function**.

d. Press **Set**.



Helicopter throttle and pitch curve adjust functions, hover trim and more

d. Here at the Throttle Hovering adjustment screen we can select to place the throttle hover trim on a control, press **SEL**.

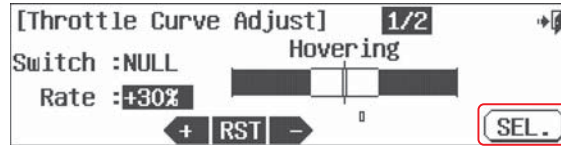

e. Select the **LT, CT, RT** or right slider (**RS**) to control the throttle hover adjustment.

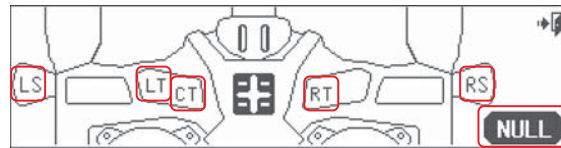

f. Press the **Exit** when done selecting a controller.

g. Adjust the rate value with the **+RST-** icon if you want to expand or decrease the adjustment size capability of the selected controller.

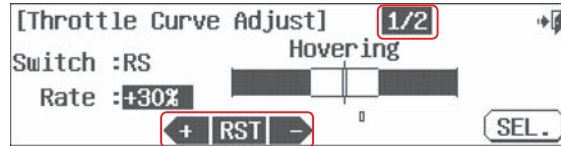

h. At this time you can select page two of the adjust menu, by pressing the **1/2** fraction icon.

i. If you want to set-an adjustment switch for the throttle hovering with pitch option, do so as described in this section, d through g

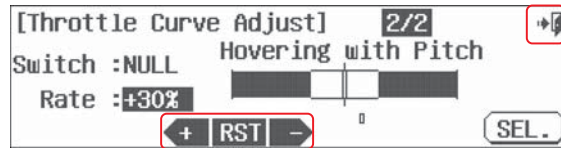

j. Press the **Exit** to return to the throttle curve menu.

Trim Link Activation

Modern computer radios use a digital trim system. The Aurora features four trim controls for the throttle and the three main axis of flight, pitch (elevator), roll (aileron) and yaw (rudder).

There are occasions we may want to link the trim of one control, to another control. The Aurora offers two different trim link features; the "Adjust to Trim" and the "T.APP" (trim apply). Both are explained in the following text.

Adjust to Trim

You will see the "Adjust to Trim" option in the throttle control menus, throttle cut, idle down and throttle hold.

The goal of activating the "Adjust to Trim" feature is to link the rate values we programmed for throttle positions, so they can be adjusted with the throttle trim.

Our example will be the Idle down function.

a. At the idle down function switch menu screen press the Adjust to Trim : **INH**.



b. Select **ACT** to activate the trim link. (this screen not shown)

c. Reverse this process to inhibit, or turn off the trim link.

Trim Link Activation

T.APP

The T.APP or "Trim Apply" is a trim link feature allowing the linking of two flight control trim functions, primarily a feature of critical mixing functions.

Again we use the aileron to rudder mix as an example. The default is to have the trims separate.

To activate a trim link between aileron and rudder, so that adjusting the aileron trim will also adjust the rudder trim;

a. At the rudder /aileron swith menu screen, press the T.App : **INH**.

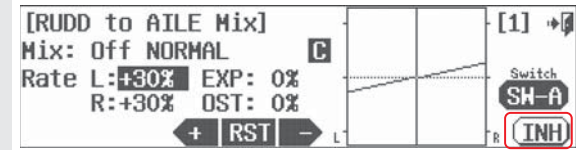

b. Press **ACT**, the trim link is turned on.

c. Reverse this process to inhibit, or turn off the trim link.

Cut Position set-up

Cut position is used to set an initiation point or a cut-off point for a specific function.

We will use the Throttle Cut feature in our example.

After selecting the recommended throttle cut switch H, do the following.

a. At the Throttle Cut menu screen press the **Cut Position** icon.



b. Move the throttle stick up and down, note the line on the bar graph as it moves.

c. Press the **50%** icon on the graph.

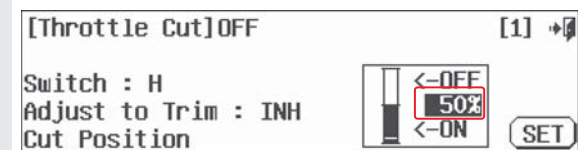

d. Move the throttle stick to the position you want the throttle cut action to take effect. Note the throttle will drop to the rate position you previously selected when the switch H is toggled, ONLY WHEN THE THROTTLE STICK POSITION IS BELOW THE CUT POSITION you are about to set.

e. We suggest you move the throttle stick to the 30% position, then press **SET**.



The throttle cut feature is now going to work only when the throttle position is at the lower 1/3rd. of the throttle stick travel stick, and then only when switch H is toggled.

Lunch Cut switch set-up

The launch mode features the option to have the cut control be applied to a stick movement.



The launch function must have a switch assigned to it for the cut function to work.

a. At the launch mode switch menu, press the Cut Function : **NULL** icon.



b. Press **SEL.**

c. For our example we will place the Launch cut on the elevator. Press **ELEV.**

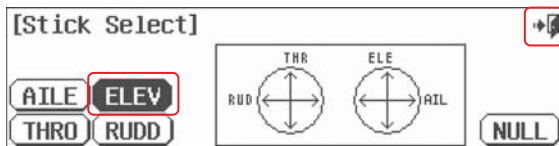

d. Select the **Exit** and return to the Launch mode switch menu.

e. Press the Cut Function : **ELEV** icon.



f. Move the elevator stick up and down. Note the movement displayed on the bar graph.



g. Press the **100%** icon on the bar graph.

h. Move the elevator stick to the cut position. For our example, move the elevator stick half way up (away from you as in "down" elevator input) hold it there and press the set icon. We are looking for about a 75% value.



i. Press the top **OFF** icon.



j. Then press the **On** icon.

The result is the ability to select a launch mode by turning it on with your switch. The flaps, ailerons and elevator should move to their pre-programmed launch position for a pedal launch or high start. At the apex of the launch, when the "round-out" process is started with down elevator input, the launch mix is "cut" or de-activated when the down elevator is applied.

Model Menu and More... Menu Functions Common to all ACRO, GLID and HELI models.

The following features are common to the ACRO, GLID and Heli model programs. Depending on the active models features as you defined them during the model set-up process, these functions may, or may not be in the model menu.

The following functions are defined in this section;

- EPA End Point Adjustment
- D/R&EXP Dual Rates and Exponential (expo) Rates
- Sub-Trim Servo Sub-Trim Adjustment
- Reverse Servo Reversing Function
- S. Speed Servo Speed Feature
- Monitor Active Model Control Monitor
- P. Mixs Programmable Mixing
- FailSafe Servo Position FailSafe in QPCM Mode
- Gyro Gyro Functions

Access the model menu from the home screen by pressing the **aircraft** icon representing the active model.

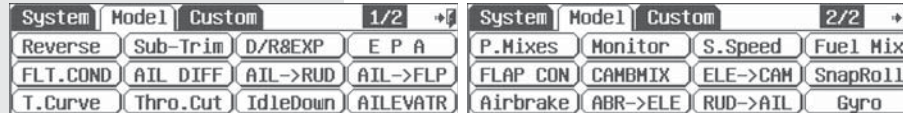

Note the 1/2 icon. There are normally two pages to the model function menu, in very sophisticated airframes there can be three pages.



It is recommended you start the set-up of your model using the functions listed in the following order;

1. Servo Reverse, page 79.
2. Sub-Trim, page 79.
3. EPA or end point adjustment, page 77.

After programming these very basic functions, your model will be prepared for more advanced programming.

EPA (End Point Adjustment)

EPA stands for "End Point Adjustment". With the EPA function you can set both sides of the servo arm travel at the same time, or separately. This function can help avoid binding or damaging the aircraft control surfaces.



- There are two screens to the EPA menu. Note the 1/2 icon.
- The EPA range is 0% to 140%.
- Sub-Trim and Dual Rate functions can impact the programmed EPA values.

a. Select **EPA** from the Model menu.

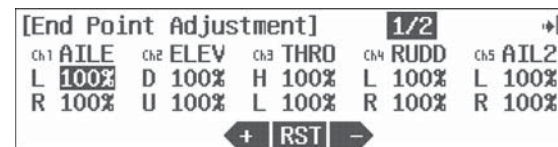

b. Press the icon of the servo channel you wish to adjust.

c. Move the aileron control stick all the way to the left. The **L 100%** should be highlighted.

d. Using the **+ RST -** icon set an appropriate movement value.

e. Now move the stick right and set the travel value for the right aileron function.

f. Repeat these steps for all the channels you wish to set an EPA value.

g. When done, back up to the model menu by selecting the **Exit** icon.

D/R & EXP (Dual Rates and Exponential Rates)

This menu contains three valuable features. We will first discuss and show a dual rate set-up, then discuss and demonstrate exponential, or "expo". The OST (Offset) feature can be applied to any channels "movement graph" as required. It will be discussed last.

This function can be influenced by the flight condition feature

Dual Rates, Exponential Rates and Curve Offset Features

Dual rates allow the user to set two or three servo throw "rates" for a control surface, or channel. These movement rates are then selected during flight with a switch.

Exponential rates (expo) is a gem of a feature, often overlooked; expo can make a poor pilot look great. We bet you will want to use a negative expo value on all your aircrafts aileron and elevator controls.

While not as widely used as Dual rates and Expo, the Offset curve feature allows you another way to change the normally linear servo movement and "skew" it.

a. Select **D/R & EXP** from the Model menu.

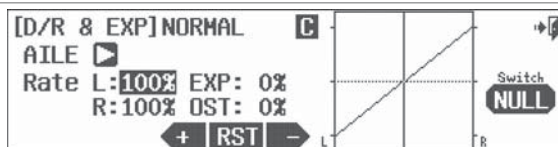

Switch Option

b. Press **NULL** to apply the dual rate function to a two or three position switch. You can have a different rate on each switch position. See page 68 for the switch selection process.

Switch type	Function
2 or 3 position switch	Multiple values

- Cycle through the active model controls using the **arrow** icon. Select the control you want to program a dual rate setting for.
- Move the control stick for that channel and hold it at the extreme throw position. Select a value for that stick positions low rates using the **+RST-** icons.
- Move the control stick to opposite extreme position, hold it there and set a value for that stick positions low travel value rate.
- This low travel rate is now active in current position of the switch you selected in section b. Flip the switch to the next position and the values should be at 100%. The 100% value is your high rate for that control.
- At this point, we suggest you press the **EXP: 0%** icon. Adding a negative value here will skew the movement curve from linear to exponential. We suggest a -50% value be used on your high and low rate switch position.
- Press the **OST: %** icon. Note the effect of the **-** and **+** inputs from the **+RST-** icon. Modify the curves of the flight controls surfaces as required.
- Set a dual, exponential and offset curve value rate for any other channels, or servos by pressing the **arrow** icon to cycle through the active models controls and following these directions.
- Press the **Exit** icon to exit back to the model menu.



- There are hundreds of combinations of expo and dual rate values that can be created within the Aurora's model programming menu. Experiment to see what works best for you.
- Put the dual rates for several different controls on the same switch, or have them be activated by a different switch.
- Make sure you are adding values to channels with the switch in the correct position.
- Add your expo values when you set-up the dual rate values as you get more experience with your Aurora.

Sub-Trim (Servo Sub-Trim Adjustment)

Your servo control arms should be as close to 90 degrees as possible, and the control surfaces as close to level as you can make them by adjusting the control linkages. Use the sub-trim feature to make very small adjustments to "center" the control surface.

a. Select **Sub-Trim** from the model menu.

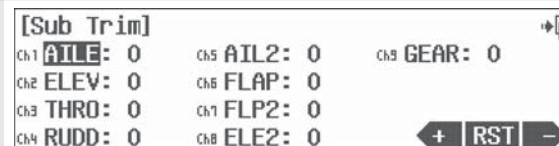

b. Select the control/channel to adjust by pressing its respective icon.

c. Using the **+RST-** icon at the screens lower right corner, adjust a value as necessary by selecting the plus or minus icon. Select **RST** to bring the value back to zero if you wish. You should see the control surface moving as changes are made with the **+** or **-** icon.

d. Follow this procedure for any channels requiring sub-trim.

e. When done, back up to the model menu by selecting the **Exit** icon.



Sub-trim is not the place to do a major adjustment. Any servo needing more than 40 points of movement should be adjusted by moving the servo control horn and adjusting the linkage.

Reverse (Servo Travel Direction Reverse)

Are all your servos traveling in the correct direction? Use this menu to change the direction for any of the active models channels.

a. Select **Reverse** from the model menu.

b. Move your controls, are all the servos going in the correct direction? If not, select the channel to reverse, then press the **REV** icon.



c. If this is correct press the Sure? **Yes** icon.

d. Do this process until all servo throw directions are correct.

e. Back up to the model menu by selecting the **Exit** icon.

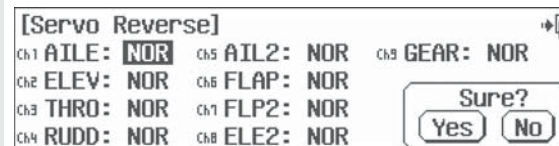

S. Speed (Servo Speed Adjustment)

The servo speed menu will allow the manipulation of the servo speed through its travel. Servo speed can also be modified in several other menus using the ACC (acceleration) feature and the Speed option.

This function can be influenced by the flight condition feature



Note

- Servo speed can only be slower.
- Choose to slow the transit speed of the selected channel in one direction, or both directions.
- The value applied is in seconds.
- The servo speed function is a two screen menu. Note the 1/2 icon.
- Servo speed values can be changed in different flight modes.

- Select **S. Speed** from the model menu.
- Press **ACT** to activate the servo speed function.



- Choose the channel to change by pressing its icon.
- Press the **+** icon to select a value to slow the servo transit time.
- Press **RST** to return the value to zero.
- When finished, press the **Exit** icon to return to the model menu.

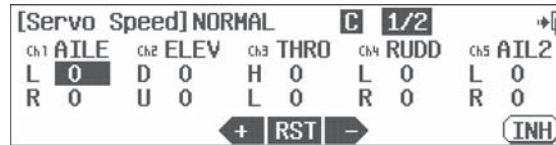

Monitor (Control Movement Monitor)

The servo monitor function will display a graphic representation of all nine channels as they are manipulated with the Auroras controls. There is also an Auto test function that will cycle through the servo movement automatically.



Note

Only channels used for the active model are shown to move on the monitor screen.

- Select **Monitor** from the model menu.
- Move the controls around and see the bar graphs move.
- Select the **Exit** icon to return to the model menu.

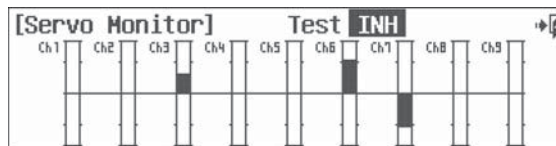

Servo Monitor Auto Test function

- At the servo monitor screen press the **Test INH** icon.
- This will cause an automatic cycle function for all active model control channels.
- Use the throttle stick position to increase or lower the auto test speed.
- Press **Test ACT** to return to the manual test mode.
- Select the **Exit** icon to return to the model menu.

P. Mixs (Programmable Mix Menu)

The Aurora is capable of eight P. Mixes. Due to the number of ways the nine channels can be mixed, we want to illustrate an example of P Mix or "programmable mixing". For this example we will mix throttle to rudder. The goal is to apply a small amount of rudder as the throttle is advanced to counteract the P-factor.

This function can be influenced by the flight condition feature

- Select **P. Mixes** at the Model menu.
- Select **INH** for the first open P mix on page 2/2.
- Press **ACT** to enter the P mix program menu.

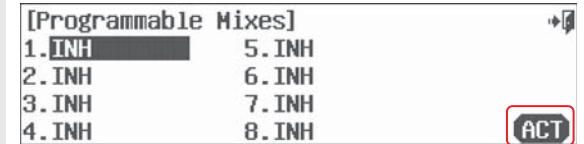

- Press the **THRO** icon.

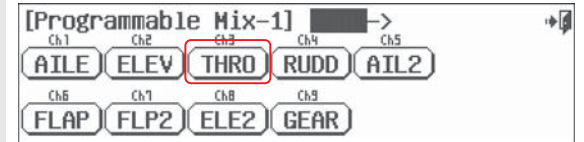

- Press **RUDD**.



- Select the **Exit** icon.



- We are now back at the first P mix screen, our P mix 1, THRO-RUDD should be highlighted.

- Press **Select**.

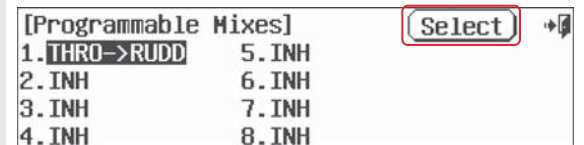

P. Mixs (Programmable Mix Menu)

i. In our example, throttle control is the “master”, if the throttle is moved the rudder will move. We must add the amount or “rate” value we want the rudder to move. Move the throttle stick up and down, the H and L values will alternately be highlighted and the throttle line will cross the graph.

j. With the throttle at the low position, add +10%.

k. With the throttle at high position, add +10%.

l. Press the OST: 0% icon.

m. Give the OST function a +10 value, note the line movement.

n. Use the ACC feature to change the speed of the mix. Press the ACC: 0% icon. Experiment with positive and negative values watching the results on your model.

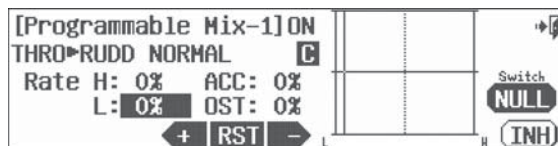

Our goal has been reached. Now as the throttle is advanced, a slight amount of rudder is automatically mixed in to counteract the tendency the aircraft has to turn in the direction of the prop rotation.

Switch Option

o. We can choose a 2 position switch to switch the mix on or off and activate a trim link. Press NULL and see page 68 for the switch selection process.

Switch type	Function	Trim link
2 position	On or Off	Yes, T.APP

p. Select the Exit icon to return to the model menu.

FAIL SAFE (Hitec QPCM Fail Safe Set-up)

FailSafe is available in both the QPCM and 2.4 mode. In the interests of safety, we recommend that FAILSAFE should always be activated, and the FAILSAFE settings should be selected so as to bring the model to a non-critical situation (e.g. motor idle / electric motor OFF, control surfaces neutral, airbrakes extended, aero-tow release open, etc.)

If you use the FAILSAFE function, and set it up properly, should the receiver signal be somehow interrupted or interference were to occur, the servos will move to your pre-set FAILSAFE point you previously stored in the receiver during the FAILSAFE set-up process.



2.4GHz system FAILSAFE setup is located on page 19.

QPCM FAILSAFE setup

- Select the FailSafe icon from the model menu
- Press F/S icon to turn FailSafe function on.



c. For this step, make sure your transmitter is transmitting and have your aircraft turned on with all the controls working correctly.



d. Move the transmitter controls so the aircrafts control surfaces are in the position you want them to be should FailSafe become activated while you are flying.

e. Now press the Set icon. Let go of all transmitter controls. FailSafe is now activated for this model.

f. Press the Exit icon to save the FailSafe position.

g. Check your FailSafe positions by turning off the transmitter and confirming your aircrafts flight control surfaces move to your FailSafe position.

Gyro (on/off and Sensitivity Adjustment)

It is often desirable to use a gyro on one or more flight control surfaces of both fixed wing aircraft and the on the tail rotor of helicopters. The Aurora features up to three gyro sensitivity and switch control options per model memory, GY-1, GY-2 and GY-3.

This function can be influenced by the flight condition feature



Note

To effectively set-up the gyro sensitivity function you should have the gyro manufacturer's instruction manual available to you.

Gyro set-up for fixed wing aircraft

a. We first associate a gyro sensitivity function to an open channel.

b. In the system menu, select **Channel**.

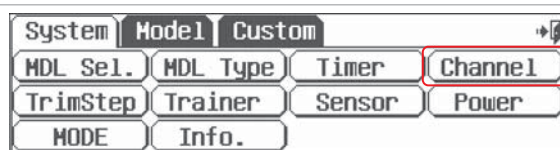

c. Add a gyro channel by pressing the **AUX1** icon.
d. Press **SEL.**

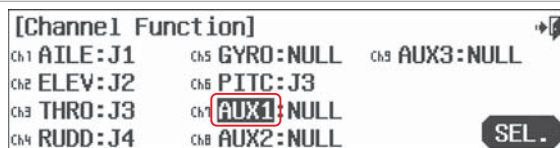

e. Choose **GY-1**.

f. Press **SET**.

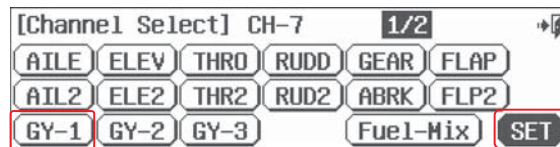

g. Press the **Exit** icon once.



h. Select the **Model** menu.

i. Select **Gyro** from the model menu.



Gyro (on/off and Sensitivity Adjustment)

j. Press **ACT** to activate the gyro sensitivity menu.



Switch Option

k. Here we can choose a two or three position switch to apply different sensitivity values. See page 68 for the switch selection process.

Switch type	Function
2 or 3 position	Multiple values

l. The default sensitivity value is 50%. According to the gyro manufacturer's guidelines, apply an appropriate % value with the **+ RST -** icons to all the different switch positions for the switch you have selected.



m. Select the **Exit** icon to return to the model menu.

Model Menu_Common Model Functions to ACRO and GLID

The following features are common to the ACRO and GLID model programs. Depending on the active models features as you defined them during the model set-up process, these functions may, or may not be in the model menu.

FLT.COND	Flight Conditions	
Airbrake	Airbrake control	
ABR- ELE	Airbrake to Elevator mix	
AIL-RUD	Aileron to Rudder mix	
ELE-CAM	Elevator to Camber mix	
RUD-AIL	Rudder to Aileron mix	
AIL DIFF	Aileron Differential feature	
AIL- FLP	Aileron to Flap mix	
CAMBMIX	Wing trailing edge mix	
FLP CON	Flap control mix	
V.Tail	V-Tail mix feature	
AILEVATR	Split elevator and aileron inclusion mix	
Elevon	Elevon or flying wing mix	
Fuel Mix	Fuel mixture control adjustment	
Thro.Cut	Throttle cut position	
T.Curve	Throttle curve	
IdleDown	Throttle Idle down position	
B-fly	Butterfly or "Crow" mix	
SnapRoll	Snap roll function	ACRO only
Motor Launch	Glider motor control feature Launch mix	GLID only GLID only

FLT.COND (ACRO and GLID)

Flight Conditions

The Flight Condition feature is clearly the most sophisticated and flexible of all the Aurora functions.

There are 7 flight conditions, Condition 2 through 8. This is in addition to the NORMAL condition for a total of 8 different flight conditions you can program for the active models memory.

As you read the manual, note this graphic appears at the end of the description text on the following functions;

This function can be influenced by the flight condition feature

The following Aurora features support flight condition programming in ACRO and GLID.

- | | |
|-----------------------------|-------------------------|
| 1. Dual Rate & Exponential | 11. Aileron to Flap Mix |
| 2. Servo Speed | 12. Camber Mix |
| 3. Programmable Mixes | 13. Launch |
| 4. Throttle Curve | 14. Flap Control |
| 5. Fuel Mixture | 15. Gyro Sensitivity |
| 6. Airbrake to Elevator Mix | 16. Snap-Roll |
| 7. Aileron to Rudder Mix | 17. V-tail Mix |
| 8. Elevator to Camber Mix | 18. Elevon Mix |
| 9. Rudder to Aileron Mix | 19. Ailevator Mix |
| 10. Aileron Differential | |



You are not obligated to use the flight condition feature to fly an aircraft.

FLT.COND (ACRO and GLID)

The flight condition tutorial

To show you how to set-up, and use the Aurora flight condition feature, follow along with this tutorial. You can change the switch location and other options when you choose to do this on your own later.

We will create two flight conditions, condition 2 and 3. These two new flight conditions are in addition to the NORMAL condition. When we are done, the NORMAL condition will be with the C switch back, or in the [0] position. The condition 2 will be active when the switch is in the middle, or [1] position. Condition 3 will be active when the switch is placed forward, or in the [2] position.

a. Press **FLT.COND** in the model menu

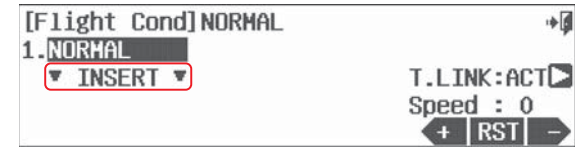

b. Press **Insert**

c. Press **Cond-2**

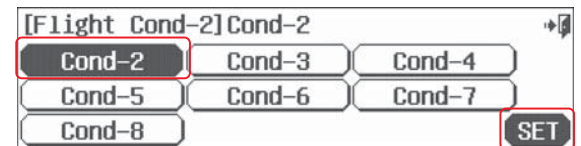

d. Press **SET**

e. Press **NULL** to select a switch

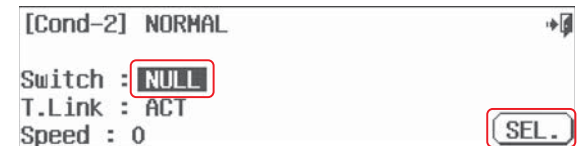

f. Press **SEL**

g. Press the **C** icon for the 3 position switch, C

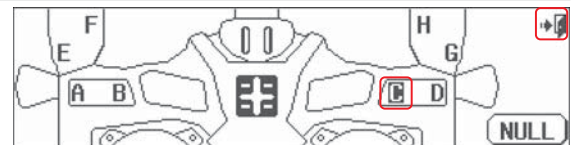

h. Press the **Exit** icon

i. Move switch **C** and note the changes to the switch icon. With the switch in the middle position, press the **OFF** middle position icon.

j. Press the **ON** icon.

k. Press the **Exit** icon.

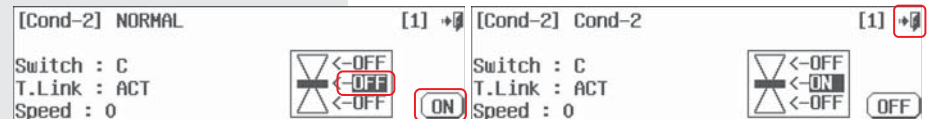

FLT.COND (ACRO and GLID)

l. Now we set-up "condition 3" the same way.
Press **INSERT**



m. Press **Cond-3**

n. Press **SET**

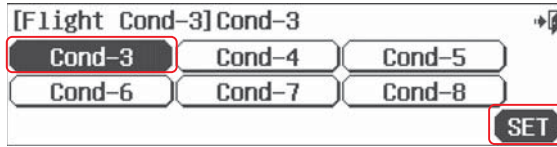

o. Select **NULL**

p. Press **SEL**

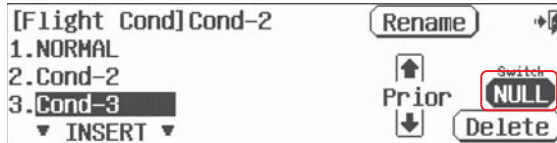

q. Press the **C** icon for the 3 position switch C

r. Press the **Exit** icon

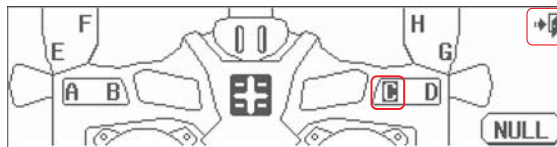

s. Move switch C forward to the [2] position. Press the **OFF** lower position icon.

t. Press the **ON** icon.

u. Press the **Exit** icon



We now have programmed a NORMAL, a condition 2 and a condition 3, flight condition setting on switch C.

FLT.COND (ACRO and GLID)

At this point we can choose to modify the existing flight conditions we made.

1. Delete any of the flight conditions you made.
2. Rename an existing flight condition to reflect its purpose.
3. Add more flight conditions and apply them to other switches.
4. Change the selected flight conditions priority
5. Decide if you want the added flight conditions to have a "trim link"
6. Add a time delay to the activation of the flight conditions

1. Delete any of the flight conditions you made.

- a. Select the flight condition to delete
Press **Delete**



- b. Press **Yes** to delete the selected flight condition

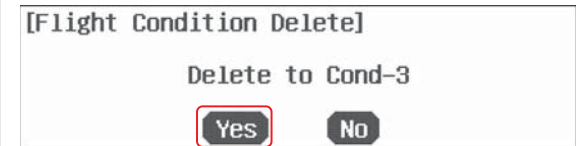

2. Renaming an existing flight condition to reflect its purpose.

- a. Press **Cond-2**



- b. Select **Rename**

- c. Name the flight condition to identify it with "what it does". If for example, this flight mode is for slow flight, name it "Slow Fly".



- d. Press **Enter** when done.

FLT.COND (ACRO and GLID)

3. Add more flight conditions and apply them to other switches.

Follow section b through k as noted previously in this section.

4. Change the selected flight conditions priority

When two or more flight modes are programmed, you may change their priority by selecting the flight condition to change, and pressing the **arrow** on the Prior icon bar.

5. Decide if you want the added flight conditions to have a "trim link"

To fine tune the movement values of a flight condition, you may want the trim to be changeable, or to follow the other flight modes. This is done at the T.LINK: INH arrow icon. Pressing the arrow will toggle between INH and ACT to inhibit or activate the trim link function for the selected flight condition.



Trim link and condition speed can be adjusted on the flight condition list screen for NORMAL condition. Change the trim link and condition activation speed for all other flight conditions on their respective switch select screens.

6. Add a time delay to the activation of the flight conditions.

Most users will desire a flight condition to be smoothly applied and retracted. Adjust the condition speed with the Speed : 0 icon using the **+RST-** icons.

C and S, Combination and Separate "movement value" set-ups.

This is a huge feature. Take the time to understand it, as using the C and S option will expand the Aurora's capability in a dramatic way.

When you have several different flight modes set-up, as you program control surface movement values into any of the following features, you can choose to have those values be associated with the C or S icon. This means;

- The C values will work in **combination** with all other features with a C value.
- The S values will work **separately** from the C value functions.

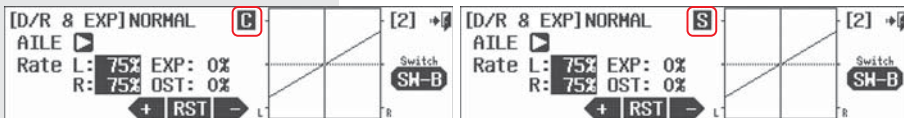

Press C to change it to S (Separately)

Press S to change it to C (Combination)



Applying the C or S option to any feature with a flight condition option, multiplies the capability of the Aurora. The default for all features will be the C values. As with most of the Auroras features, experimentation is encouraged as experience is truly the best teacher.

Airbrake (ACRO and GLID)

Airbrake Function and Landing Mode.

The Airbrake function will be used for a switch to deploy a spoiler or airbrake flight surface.



- This function is to be programmed on a switch. It is on, or off. For progressive, proportional deployment of an airbrake with a slider control, use the Airbrake to Elevator function on page 92.
- If you program the airbrake function on a switch in this menu, the Airbrake to Elevator function mix progressive airbrake deployment feature will not work.
- If your model does not have an airbrake, this function can be applied separately to the ailerons, elevator and flaps to move them to a "spoileron", "crow"/"butterfly" and other creative flight control positions with the selection of a switch.

- During the model type set-up in the system menu, select **Airbrake** if your model is to use an airbrake. This will apply the airbrake to a channel within the models program.

a. Select **Airbrake** from the model menu.



b. Press the **ACT** icon to enter the airbrake menu.



Switch Option

d. Press **NULL** to apply the airbrake activation to a two position switch. See page 68 for the switch selection process.

Switch type	Function
2 positions	On or Off

e. Deployment of the airbrake can be mixed to most major flight controls. Select the control to apply a rate value, and press the **+RST-** icons.

f. Select a **Speed** value to have the airbrake deploy over a selected period of time.

g. Press the **Exit** icon to go back to the model menu.

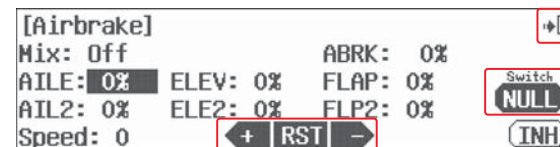

ABR- ELE (ACRO and GLID)

Airbrake to Elevator Mix.

Airbrake to elevator mix is used to progressively deploy an airbrake and/or a landing configuration. The elevator compensation will counter the pitching of the aircraft when an airbrake is deployed. The default is the airbrake on the RS(right slider) control.



This function will not work if you have the Airbrake function already programmed on a switch as described in Airbrake function, page XX.

Apply the airbrake to a control

a. During the model type menu set-up you should have selected airbrake as a model function. Airbrake needs to be applied to a control, we suggest the right slider or RS control.

b. From the home screen, press the **System menu (wrench)** icon.

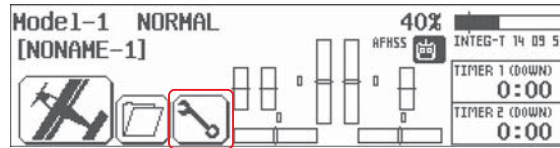

c. Select **Channel**.



d. Press ABRK: **NULL**.

e. Press **SEL**.



f. Select **RS**.

g. Press **SET**.

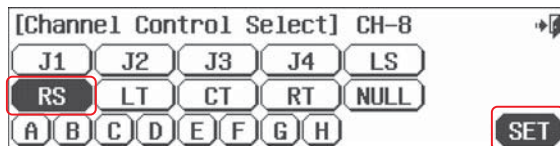

h. Back at the channel function menu, press the **Exit** and return to the system menu.



ABR- ELE (ACRO and GLID)

Program an airbrake to elevator mix

i. Select the **ABR-ELE** function icon from the model menu.

j. Press **ACT** to access the menu screen.



k. Apply a % value for the elevator movement rate using the **+RST-** icons. Note the movement of the elevator as per the line on the graph. Add enough elevator movement so the aircraft remains stable in flight during the airbrake deployment.

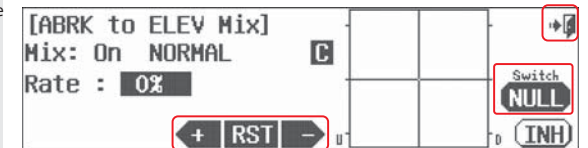

l. Press the **Exit** icon to exit back to the model menu.

Switch Option and In-Flight Fine Trim Adjustment Switch Function

m. To select a switch that will turn the mix on and off and to select an "in-flight" ADJUSTMENT switch, press **NULL** and follow the switch activation process on page 68.

Switch type	Function	VR adjustment
2 position	On or Off	Fine tuning control choice

AIL-RUD (ACRO and GLID)

Aileron to Rudder Mix.

Provide your large scale aircraft or sailplane with an aileron to rudder mix for smooth, coordinated turns.

This function can be influenced by the flight condition feature

a. Select the **AIL-RUD** icon from the model menu.

b. Press **ACT** to access the mix menu screen.

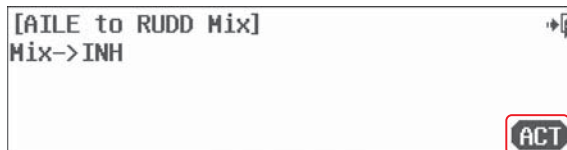

Switch Option and In-Flight Fine Trim Adjustment Switch Function

c. To select a 2 position switch that will turn the mix on and off, select an "in-flight" ADJUSTMENT switch, and choose to activate the trim link feature, press **NULL** and follow the switch activation process on page 68.

Switch type	Function	Trim link	VR adjustment
2 position	On or Off	Yes, T.APP	Fine tuning control choice

d. The default rate for the mix is 30%. Change the rudder movement value with the **+RST-** icon. Note how the rudder movement changes are shown on the graph.

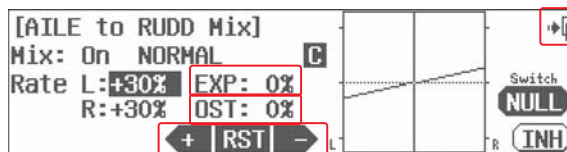

e. To fine tune the input of the rudder, apply a negative value with the exponential function shown as **EXP : 0%**.

f. Additional adjustment can be applied to the rudder mix using the Offset **OST : 0%** value.

g. Press the **Exit** icon to return to the model menu.

ELE-CAM (ACRO and GLID)

Elevator to Camber Mix.

The elevator to camber mix allows the model to drop and raise the entire trailing edge of your models wing control surfaces as the elevator is used.

As in many of the Auroras model menu options, there are several airframe variables that are selected and appeared in the different menu screens. In the case of the elevator to camber mix, the number of flaps and ailerons will appear as a variable based on the airframe type you told the radio you had at the time of initial model set-up in the system menu.

This function can be influenced by the flight condition feature

a. Select **ELE-CAM** from the model menu.

b. Press **ACT** to activate the mix.



Switch Option and In-Flight Fine Trim Adjustment Switch Function

c. To select a 2 position switch that will turn the mix on and off, select an "in-flight" ADJUSTMENT switch, and choose to activate the trim link, press **NULL** and follow the switch activation process on page 68.

Switch type	Function	Trim link
2 position	On or Off	Yes. T.APP

d. The default adjustment values are for the ailerons. Use the **+RST-** icon to set the mix movement value for all the ailerons on your aircraft.

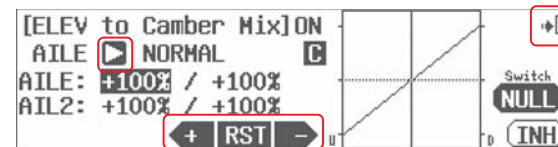

e. Select the **Arrow** icon to change to the flap movement value screen.

f. Again use the **+RST-** icon to set the value for the flaps. Note the flaps will only appear as an option if you told the radio your model had flaps when it was set-up.

g. Select the **Exit** icon to return to the model menu.

RUD-AIL (ACRO and GLID)

Rudder to Aileron Mix.

If you wish to mix aileron into a rudder input, follow the directions below.

This function can be influenced by the flight condition feature

a. Select **RUD-AILE** from the model menu.

b. Press the **ACT** icon to enter the rudder to aileron mix.



Switch Option and In-Flight Fine Trim Adjustment Switch Function

c. To select a 2 position switch that will turn the mix on and of, select an "in-flight" ADJUSTMENT switch, and choose to activate the trim link, press **NULL** and follow the switch activation process on page 68.

Switch type	Function	Trim link
2 position	On or Off	Yes. T.APP

d. The default rate for the mix is 30%. Change the aileron movement value with the **+RST-** icon. Note how the aileron movement changes are shown on the graph.

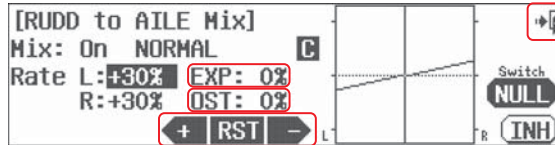

e. To fine tune the input of the aileron, apply a negative value with the exponential function shown as **EXP: 0%**.

f. Additional adjustment can be applied to the mix using the Offset **OST: 0%** value.

g. Press the **Exit** icon to exit back to the model menu.

AIL DIFF (ACRO and GLID)

Aileron Differential.

Aileron differential is generally used to provide more up aileron, than down aileron travel. This will help prevent adverse yaw conditions when banking and rolling the aircraft.

This function can be influenced by the flight condition feature

a. Select the **AIL DIFF** icon from the model menu.

Switch Option and In-Flight Fine Trim Adjustment Switch Function

b. To select a 2 or 3 position switch that will allow multiple differential values to be used, turn the feature on and off, and to select an "in-flight" ADJUSTMENT switch, press **NULL** and follow the switch activation process on page 68.

Switch type	Function	Trim link
2 position	On or Off	Yes. T.APP

c. Select which aileron, and the direction you wish to limit the travel of.

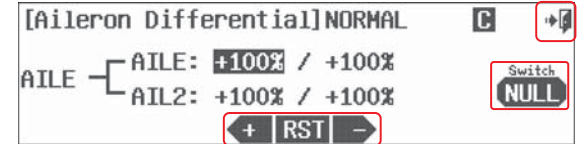

d. Input a value with the **+RST-** icon.

e. Press the **Exit** icon to return to the model menu.



- A value that equates to 50% "down" aileron travel compared to 100% of the "up" aileron travel is a good place to start.
- Use the **ADJUST** feature described in the switch set-up process to make fine in-flight adjustments.

AIL- FLP (ACRO and GLID)

Aileron to Flap Mix.

Aileron to flap mix can be set up to allow the full trailing edge of the wing, (flaps and ailerons) to move together acting as one large aileron on each wing panel.

This function can be influenced by the flight condition feature

- a. Select the AIL-FLP icon in the model menu.
- b. Select ACT to activate the feature.

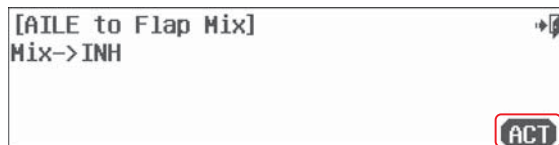

Switch Option and In-Flight Fine Trim Adjustment Switch Function

c. To select a 2 position switch that will turn the mix on and off, select an "in-flight" ADJUSTMENT switch, and to apply a trim link, press NULL and follow the switch activation process on page 68.

Switch type	Function	Trim link	VR adjustment
2 position	On or off	Yes, T.APP	Fine tuning control choice

- d. Select the flap and travel direction you want to change the rate value for.
- e. Use the +RST- icon to change the travel rate value. You may want to match it to the aileron travel.
- f. Select the Exit icon to return to the model menu.

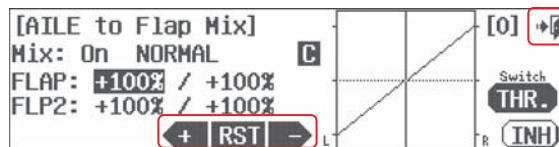

CAMBMIX (ACRO and GLID)

Wing Trailing Edge Camber Mix.

Mix the ailerons, flaps and elevator onto an Aurora control with the Camber mix feature. Provide one switch or variable control to lower and raise the trailing edge while using elevator compensation.

This function can be influenced by the flight condition feature

- a. Select the CAMBMIX icon from the model menu.
- b. Press ACT to activate the Camber mix menu.

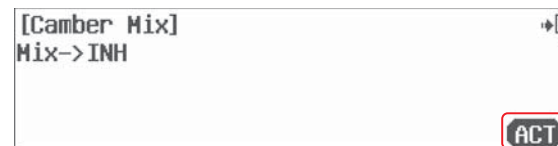

c. The first decision is where to place the camber mix function control. We suggest the default of the RS (right slider) to begin with. You can change it later if you wish by selecting the arrow on the top line of the screen and selecting another control for the camber mix.

Switch Option and In-Flight Fine Trim Adjustment Switch Function

d. To select a 2 position switch that will turn the mix on and off and to select an "in-flight" ADJUSTMENT switch, press NULL and follow the switch activation process on page 68.

Switch type	Function	VR adjustment
2 position	On or Off	Fine tuning control choice

- e. Use the arrow icon next to the AILE to cycle through the control surfaces that can be manipulated with this feature. Select one.
- f. Input a movement value using the +RST- icon.
- g. Repeat this process until the ailerons, flaps and elevator flight control channels all move where you want them too.
- h. Select the Exit icon to return to the model menu.

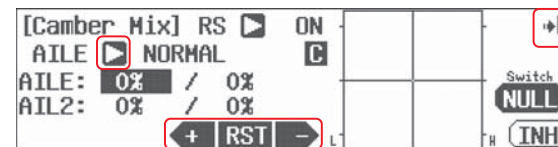

The Camber Mix feature has a second screen in the adjustment menu allowing you to set adjustment travel rate values for all the different control surfaces. See page 72 for detailed instructions.

FLP CON (ACRO and GLID)

Flap to Elevator Mix.

Flap Control will mix the elevator into any flap movement to avoid pitch changes as flaps are deployed.

This function can be influenced by the flight condition feature

a. Select the **FLP CON** icon from the model menu.

b. Press **ACT** to activate the Flap Control menu.



Switch Option and In-Flight Fine Trim Adjustment Switch Function

c. To select a 2 or 3 position switch that will allow multiple mix values, select an "in-flight" ADJUSTMENT switch, press **NULL** and follow the switch activation process on page 68.

Switch type	Function	VR adjustment
2 or 3 position	On or off	Fine tuning control choice

d. Select the flap values you want by moving the left slider flap control (default) to highlight the up or down throw.

e. Change the flap movement value with the **+RST-** icon.

f. Select the **ELEV: 0%** and apply a value to the elevator movement with the **+RST-** icon.

g. Note the addition of the elevator as the flap control is moved.

h. Select the **Exit** icon to return to the model menu.

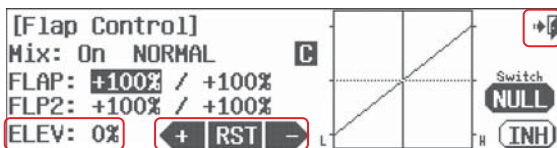

V.Tail (ACRO and GLID)

V.Tail Set up

Aircraft with a V tail can use this function to limit the travel of the tail control servos up, down or both directions.



It is not necessary to access or change this menu to fly a V tail aircraft. The default values are 100% movement in all directions.

This function can be influenced by the flight condition feature

To change the end points on the V-tail servos while they are performing the rudder and elevator functions:

a. Select **V. Tail** from the model menu.

b. The first screen allows adjustment of the elevator function. Select the control and direction you wish to change.

c. Press the **+RST-** icon to change the rate values for the elevator servo as it performs the elevator and rudder control functions. Repeat the process for all values on this menu page you want to change.

d. Press the **1/2** icon to access the next page containing the same adjustment format on the rudder control surfaces.

e. Change the rate values for the rudder servo as it performs both the rudder and elevator control functions. Repeat for all values on this page you want to change.

f. Press the **Exit** icon to back out to the model menu.

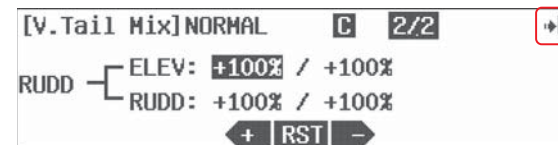
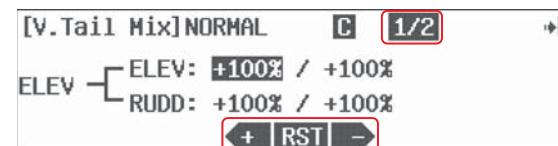

AILEVATR (ACRO and GLID)

Split Elevator and Aileron Mix Controls.

The ailervator feature allows the adjustment of a two servo or split elevator. It also features an "aileron to split elevator" mix so when ailerons are applied, the elevators move in opposite directions. This is useful for advanced "taileron" aircraft, notably jets.

This function can be influenced by the flight condition feature

a. Select **AILEVATR** from the model menu. Ailervator screen #1 for ailerons

b. There are two screens, the first to adjust the amount of elevator movement to be applied when the ailerons are moved.

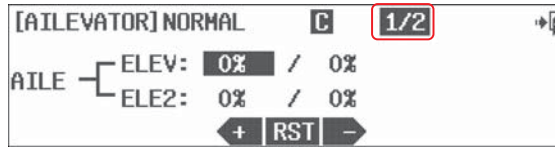

c. Press the **1/2** fraction icon to move to the second menu screen.

d. The second screen is for the elevator servo movement. This effectively sets the end points for the elevator servos.

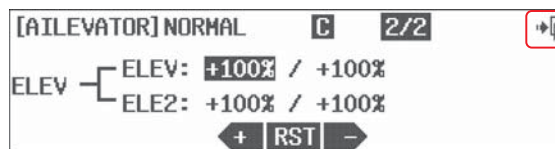

e. Select between the screens and servos to apply the rate values you want your model to use.

f. Select the **Exit** icon to return to the model menu.

Elevon (ACRO and GLID)

Flying Wing Mix.

Flying wing aircraft will most often be set-up using elevons. The Aurora mixes the aileron and elevator function to provide these controls in just one flight control surface per wing panel.



It is not necessary to access or change this menu to fly a Flying wing aircraft. The default values are 100% movement in all directions.

This function can be influenced by the flight condition feature

To change the end points on the elevon servos while they are performing the aileron and elevator functions:

a. Select **Elevon** from the model menu.

b. The first screen allows adjustment of the aileron function. Select the control and direction you wish to change.

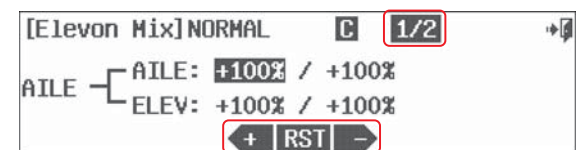

c. Press the **+RST-** icon to change the value. Repeat for all rate values on this page you want to change.

d. Press the **1/2** icon to access the next page containing the same adjustment format on the elevator control function.

e. Change the values on this page to obtain the results you require.

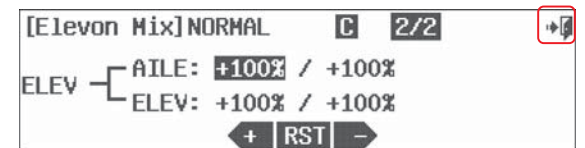

f. Press the **Exit** icon to back out to the model menu.

Fuel Mix (ACRO)

Fuel Mixture Adjustment.

There may be airframe applications where it is desirable to richen and lean out the fuel mix as the throttle is used. The fuel mix feature mixes a channel where a separate servo can be used as a needle valve control.

During the model type set-up in the system menu, select Fuel Mix if your model is to use a fuel control servo. This will apply the fuel mix menu within the models program.

A fuel mixture channel can also be applied in the System menu – MDL Type menu.

This function can be influenced by the flight condition feature



This is a feature that must be finely tuned both in the radio and on your model hardware linkages.

a. Select **Fuel Mix** from the model menu.

b. Press **ACT** to access the fuel mix menu.



Switch Option and In-Flight Fine Trim Adjustment Switch Function

c. To select a 2 position switch that will allow you to turn the mix function on and off, and to select an "in-flight" ADJUSTMENT switch, press **NULL** and follow the switch activation process on page 68.

Switch type	Function	VR adjustment
2 position	On or Off	Fine tuning control choice

d. Note the fuel mix servo is set by default to move linier.

e. Adjust the fuel mix servo end points using the throttle stick. Apply a value for high and low stick travel of the fuel mix servo with the **+RST** icon.

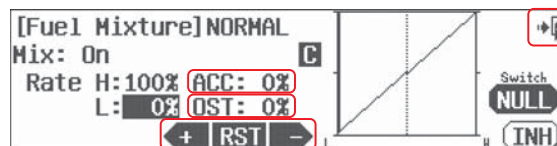

f. Use the **OST: 0%** value to skew the movement as noted on the graph when different OST values are applied.

g. Use the **ACC: 0%** feature to change the speed of the mix. Experiment with positive and negative values watching the results on your model.

h. Press the **Exit** icon to go back into the model menu.

Thro.Cut (ACRO)

Throttle Cut Position.

Many would agree a throttle cut function is required to safely fly glow and gas aircraft. The Auroras throttle cut feature will bring the throttle servo to a programmed position allowing the motor to drop to low idle or kill the power entirely. It's your choice as to how you program it.

a. Press **Thro. Cut** in the model menu. Throttle Cut activation screen

b. Press **ACT** to activate the throttle cut menu.



Switch Select

c. To select a switch that will allow you to activate the throttle cut function, select an "in-flight" ADJUSTMENT switch, and to link the throttle trim to the switched throttle cut feature, press **NULL** and follow the switch activation process on page 68. Normally throughout the Aurora manual we don't recommend a switch location. However, to trigger the throttle cut feature we believe the "dead man" switch H is the most practical location for the throttle cut switch.

Switch type	Function	Trim link	Cut position
2 position	On or Off	Yes, Adjust to trim	Cut control choice

d. Bring the throttle stick down to slightly below 1/2 stick.



e. While holding switch H forward so the throttle cut is activated, carefully apply a rate value to the **RATE: 0%** using the **+RST** icon. Watch the servo arm movement direction to see if a + or - value is required to lower the throttle to a position that will "kill" the engine. Do this slowly and make sure the throttle linkage does not bind and stall the servo. Often a manual adjustment to the carburetor "idle stop" is necessary.

f. Press the **Exit** icon to go back into the model menu.



The default throttle cut position is below 1/2 stick. Change this cut position with the throttle cut feature explained in the switch section on page 68.

T.Curve (ACRO)

Throttle Curve Adjustment.

The throttle curve function allows you to modify the normally linier servo rate movement using seven different points along the curve that can accept a movement value.

There are many options for the throttle curve feature. Surprisingly it can be one of the most complicated features of the Aurora. The good news is that you can choose to use many, or as few of the functions on this menu as you wish too.

This function can be influenced by the flight condition feature

a. Press **T.Curve** in the model menu.

b. Press **ACT** to activate the throttle curve menu.

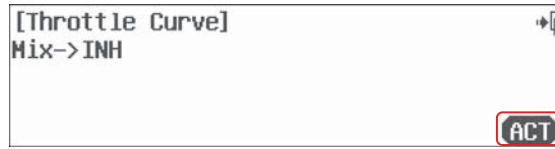

Switch Option

c. To select a 2 or 3 position switch that will allow multiple mix values, press **NULL** and follow the switch activation process on page 68.

Switch type	Function	VR adjustment
2 or 3 position	Multiple Values	Fine tuning control choice

- Note how the throttle movement is shown on the graph as a percentage value, when the throttle is advanced and lowered.

d. If you wish to change one of the curve points, use the throttle stick to place the graph line through the point you wish to change. Use the **+RST-** icon to set a new value. Note the change in the graph curve.

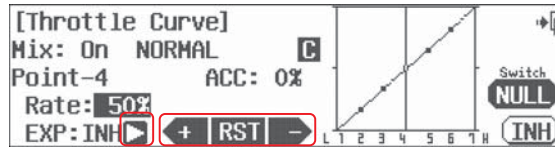

e. Inhibit (turn off), or activate (turn on) a point by using the throttle to place the graph line through the point you wish to change, press **RST**.

f. Add an exponential curve from one point to another by pressing the **arrow** next to the **EXP:INH** icon and have it switch to **EXP:ACT**. This activates the expo option between it, the prior and the next point. Use the **+RST-** icons to add a value creating a curve.

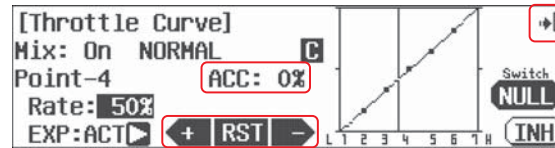

g. Change the activation speed with the **ACC** or acceleration feature. Again, using the throttle to place the graph line through the point you wish to change.

h. Select the **Exit** icon to return to the model menu.

Idle Down (ACRO)

Idle Adjustment.

The Idle Down function will apply a rate value to the throttle channel raising or lowering the throttle to a position determined by the user when a switch is activated. This position will become the low throttle point for as long as the switch is selected.

a. Select **Idle Down** from the model menu.

b. Press **ACT** to activate the idle down function menu.



Switch Option

c. To select a two position switch that will activate the idle down feature and a throttle trim link, press **NULL** and follow the switch activation process on page 68.

Switch type	Function	Trim link
2 position	On or Off	Yes, Adjust to trim

d. Using the **+RST-** icons, set the throttle down position desired. A positive value will be "above", while a negative value "below", the "normal" low throttle stick position.



e. Press the **Exit** icon to return to the model menu.

B-fly (GLID)

Butterfly or Crow Mix.

Butterfly, also known as “Crow” mixing is used to land slippery gliders easier and with greater accuracy. The mix is usually activated with the linier action of the throttle stick which drops the flaps, raises the ailerons and employs a bit of up elevator to compensate for the pitch down created by all the additional control surface drag.

This function can be influenced by the flight condition feature

a. Select **B-Fly** from the model menu.

b. Press **ACT** to activate the Butterfly control feature menu.



Switch Option

c. Select a 2 position switch and/or the throttle stick to activate the butterfly mix. Choose a “cut” point if you wish, and apply an in flight adjustment switch by pressing **NULL** and following the switch activation process on page 68.

Switch type	Function	Cut Function	VR adjustment
2 position and/or throttle	Variable function	Cut control choice	Fine tuning control choice



We suggest you choose the throttle, **THR**, as the “switch” activating the mix. This gives a linier, progressive deployment and retraction of the flight control surfaces.

d. Use the **+RST-** icon to set a movement value for the aileron, elevator and flaps. Move the throttle stick to see the effect of the movement values you selected for the flight control surfaces.

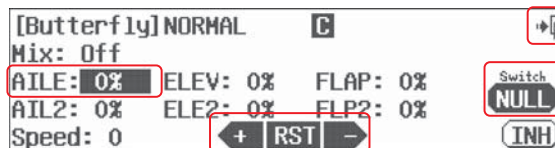

e. Select the **Exit** icon to return to the model menu.

SnapRoll (ACRO)

Automatic Snap-Roll Function.

The Snap-Roll feature will allow you to program an aileron, elevator and rudder travel rate for inside and outside snap rolls in either the right or left direction.

This function can be influenced by the flight condition feature

There are four snap types the Aurora can be programmed for;

- R/U= right, inside snap
- L/U= left, inside snap
- R/D=right, outside snap
- L/D=left, outside snap

There are two ways to accomplish the snap roll programming.

1. The **Single**, programming a master switch (usually H) for one snap “type”.
2. The **Multi**, programming a master switch (usually H) to activate the programming for two or more snap types that are programmed on other switch positions.

For clarity we will review the method to place one snap roll function on one switch using the Single option, then show how to program several switches for different snap rolls using the Multi option.

The Single Snap Roll Option

a. Select SnapRoll from the model menu. Snap-Roll activation screen

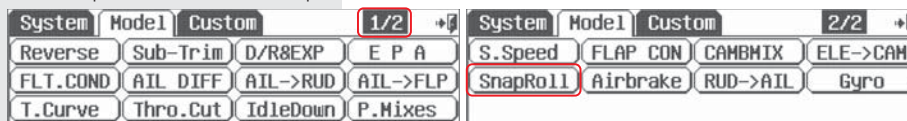

b. Press **ACT** to activate the Snap Roll function menu.

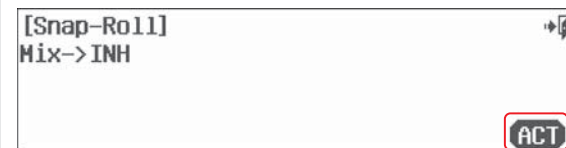

Select a master snap roll switch

c. To select a switch that will allow you to activate the snap roll feature press **NULL** and follow the switch activation process on page 68. Normally throughout the Aurora manual we don't recommend a switch location. However, to trigger the snap roll feature we believe the “dead man” switch **H** is the most practical location for the snap roll master switch function.

Switch type	Function
2 position	On or Off

SnapRoll (ACRO)

d. Press the **arrow** icon next to Direction.

e. Choose a snap "type" R/U for right inside, L/U for left inside, R/D for right outside and L/D for left outside.

f. Select the control to adjust, AILE, ELEV, OR RUDD.

g. Add a movement rate value with the **+RST-** icons

h. Repeat the process for all the controls.

i. By flipping the switch you choose for the snap roll feature, you can see the movement on your aircrafts control surface. Be prepared to make minor adjustments to your control movement rate values after flying and using the snap roll feature

j. Press the **Exit** icon to return to the model menu.



Multiple Snap Roll functions on multiple switches

a. Select SnapRoll from the model menu.

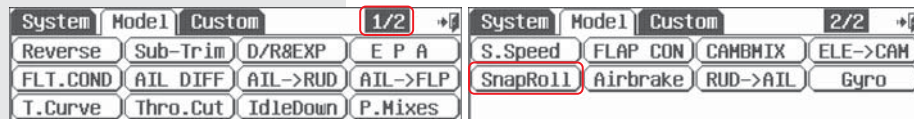

b. Press ACT to activate the Snap Roll function menu.



Select a Master Snap Roll Switch

c. To select a switch that will allow you to activate the snap roll feature press **NULL** and follow the switch activation process on page 68 as follow. Normally throughout the Aurora manual we don't recommend a switch location. However, to trigger the snap roll feature we believe the "dead man" switch **H** is the most practical location for the snap roll master switch function.

Switch type	Function
2 position	On or Off

SnapRoll (ACRO)

d. Press the **Single** icon, it will change to **Multi**.



e. Choose a snap "type" R/U for right inside, L/U for left inside, R/D for right outside and L/D for left outside.



f. Press **NULL** and return to page 68 for instructions on how to apply a switch to the snap type you selected. Otherwise, select a switch for the snap type you selected. Note the switch you selected appears on the direction part of the screen associated with the snap type you wanted.

Switch type	Function
2 or 3 position	On or Off

g. Select the control to adjust, AILE, ELEV, OR RUDD.



h. Add a movement rate value with the **+RST-** icons.

i. Repeat the process for all the controls used in the snap.

j. Flip the switch you choose for the snap roll type you selected, now trigger the master H switch, your aircraft controls should move in relation to the snap type you choose. Be prepared to make minor adjustments to your control movement values after flying and using the snap roll feature.

k. To add another snap type, repeat steps, e thru j.

l. Press the **Exit** and return to the model menu.

Motor (GLID)

Motor Control Menu.

Use the motor function available in the GLID programming to turn an electric motor on or off using a two position switch.

This function can be influenced by the flight condition feature

a. Select Motor from the model menu.

b. Press ACT to activate the Motor Control feature menu.



Switch Option

c. To select a 2 position switch that will start and stop the motor, press NULL and follow the switch activation process on page 68.

Switch type	Function	Trim link
2 position	On or Off	Yes, Adjust to trim

d. Using the +RST- icons, set the motor speed and delay values for both the "turning on and off" functions. Use the switch you selected to move between on and off.

e. Press the Exit icon to return to the model menu.

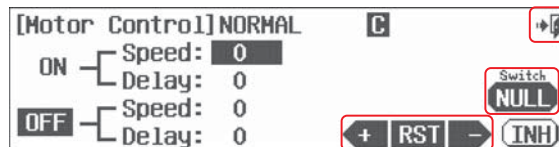

Both speed and delay values are in 0.1 second steps.

Launch (GLID)

Glider Launch Menu.

The Launch mix allows the aileron, flap and elevator functions to be mixed and deployed by selecting a switch. As the name implies, it is used to optimize the entire trailing edge of the wing for a launch mode. Try to drop the trailing edge a couple of degrees and add up elevator compensation on gliders for a better zoom launch configuration.

This function can be influenced by the flight condition feature

a. Select Launch from the model menu.

b. Press ACT to activate the Launch feature menu.



Switch Option

c. Select a 2 position switch that will activate the launch mix, create a "cut" point, and apply an in flight adjustment switch. Press NULL and follow the switch activation process on page 68.

Switch type	Function	Cut Function	VR adjustment
2 position	On or Off	Cut control choice	Fine tuning control choice

d. Use the +RST- icon to set a movement value for the aileron, elevator and flaps.

e. Select Speed: 0, and change the time value with the + icon to set a delayed control deployment speed.

f. Use the 2 position switch you selected to turn the mix on and off. Note the movement of the control surfaces.

g. Select the Exit icon and return to the model menu.

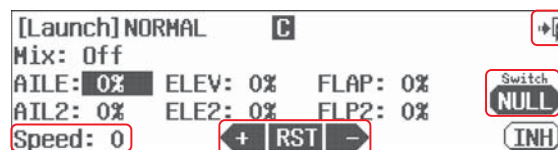

The "Cut" function for the launch mode is different than any other cut function in the Aurora. Note the method to use this feature on page 75.

Model Menu_HELI Specific Functions

The Aurora offers a rich selection of features to fly everything from the simplest, to very complex and sophisticated helis.

To the heli owner using this manual for the first time, it is recommended you proceed through the following material contained in this manual;

1. Section one introductory information
2. Section three, the heli quick start guide
3. Section four, the system menu
4. Section five, common features of all model types



After setting the heli up in the Aurora system menu through the MDL Sel. feature as described in section two, "model select" on pages 30-37, visit section five for all the basic set-up functions, then skip back to this section for the rest of the information.

The following Aurora features are specific to heli aircraft;

Flight Conditions	Flight conditions or Idle-Up menu
P. Curve & T. Curve	Rotor blade pitch curve and Throttle curve adjustment
Needle	Carburetor needle acceleration function
SWH->THR	Swash plate movement to throttle mix
RUD->THR	Tail rotor to throttle mix
T. HOLD	Throttle hold function
SwashMix	Swash plate fine tuning menu
REVO Mix	Revolution mix
Gyro	Gyro sensitivity control menu
Governor	RPM governor adjustment

These additional set-up functions are defined earlier in the manual.

EPA	End Point Adjustment	Page 77
D/R & EXP	Dual Rates and Exponential (expo) rates	Page 78
Sub-Trim	Servo Sub-trim adjustment	Page 79
Reverse	Servo reversing function	Page 79
S. Speed	Servo Speed feature	Page 80
Monitor	Active model control monitor	Page 80
P. Mixs	Programmable Mixing	Page 81
FailSafe QPCM	Servo position FailSafe	Page 83
FailSafe 2.4	Servo position FailSafe	Page 19

***** IMPORTANT PROGRAMMING TIPS *****

Throttle Lock

The Aurora features a "throttle lock" function that can be activated when the transmitter is transmitting a signal. We encourage you to apply the throttle lock as a safety precaution against "accidental throttle application".

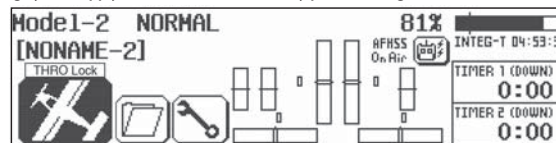

- a. Turn the throttle lock on and off from the home page by pressing the **Model** icon for two seconds. Throttle lock is confirmed when the "THRO Lock" icon is displayed.

Reset, the best hint of all

As you program a model into any computer radio, especially one as sophisticated as the Aurora, it is easy to make a mistake. If "things" just are not working the way they should, start over. There are thirty model memories in the Aurora. Start a new model or Reset the current one in the System-MDL Sel. menu. You will lose all the programming you have done for that model up to that point, but starting over is the best "cure" for 90% of all "problems" modelers have with programming issues.

With very complex models, it would be wise to "save" a programming sequence by periodically using the Copy option in the model select menu.

Switches

The functions that you program into the Aurora will be "on" all the time, noted as NULL on the specific features menu screen. All these features can be toggled on or off using a two position switch, or several different values can be applied to some features using three position switches. While still other functions like Camber are applied to a slider and their movement dialed-in as needed. All these different methods for selecting and formatting switches and other control functions are described on page 68 in the manual rather than being repeated throughout the document on every other page.

Flight conditions or Idle-Up

Idle-up is a function of the flight condition feature. The Aurora programming offers the use of one "normal", four "idle-up" modes and a hold condition. Use the flight condition feature to apply different rate values for the gyro, governor, pitch and throttle curves, and most other critical functions within each "condition". As you travel the Aurora learning curve, we encourage you to explore how the flight condition/Idle-up function can influence almost every feature of the Aurora. Of major note will be the C (combined) and S (separate) options that deliver an almost infinite number of programming combinations.

Selecting a Servo or Channel to Adjust the Value

There are three ways to select a servo to adjust;

- Use the control stick to make the adjustment. Right and left, up and down to select the direction you want to adjust. This way you see the results of your input if the aircraft is turned on.
- Press the % value icon for any single servos one direction.
- Press the name icon of the control to be adjusted and adjust both directions at the same time.

3 Axis Control Definitions

Within the Aurora programming, you will see the fixed wing generic terms for our traditional 3 axis heli control functions.

- Elev = Pitch
- Aile = Roll
- Rudd = Yaw or tail rotor control

FLT.COND (HELI)

Flight Conditions, Idle-Ups and Throttle Hold.

When a heli aircraft is selected as the active model, the flight condition function becomes the heli idle-up and throttle hold feature.

There are 8 flight conditions;

- Normal
- Idle-up 1-4
- Throttle hold
- Two open conditions, condition 7 and 8.



You are not obligated to use the flight condition / idle-up feature to fly a heli.

The following Aurora features support flight mode programming in heli mode

- Dual Rate & Exponential
- Servo Speed
- Programmable Mixes
- Throttle Curve
- Pitch Curve
- Fuel Mixture
- Needle Control
- Gyro Sensitivity
- Swash -> Throttle Mix
- Rudder -> Throttle Mix
- Governor

To show you how to set-up and use the Aurora flight condition / idle-up feature, follow along with this tutorial. You can change the switch location and other options when you choose to do this on your own later.

We will create three flight conditions, idle-up 1, idle-up 2 and throttle hold.

These two new flight modes are in addition to the "normal" condition.

When we are done, the normal mode will be with the E switch back or in the [0] position.

The idle-up 1 will be active when the switch is in the middle, or [1] position.

Idle-up 2 will be active when the E switch is placed forward, or in the [2] position. Throttle hold will be placed on switch F.

a. Press **FLT.COND** in the model menu.

b. Press **Insert**.



c. Press **Idle-Up-1**.

d. Press **SET**.

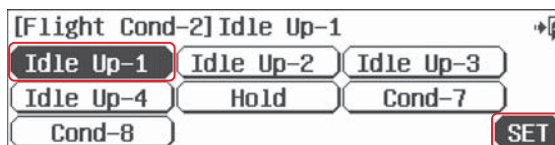

FLT.COND (HELI)

e. Press **NULL** to select a switch.



f. Press **SEL** at the Idle Up-1 switch menu (not shown) to enter the switch map.

g. Press the **E** icon for the 3 position switch E.

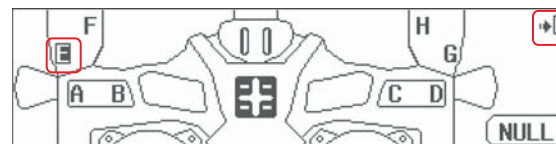

h. Press the **Exit** icon.

i. Move switch E and note the changes to the switch icon. With the switch in the middle position, press the **OFF** middle position icon.

j. Press the **ON** icon.

k. Press the **Exit** icon.

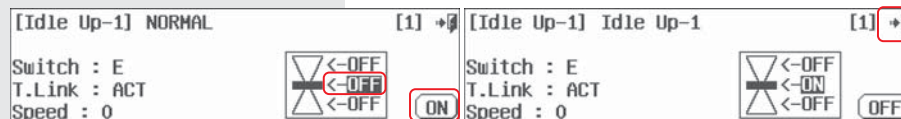

l. Now we set-up Idle-Up 2 the same way.

Press **INSERT**

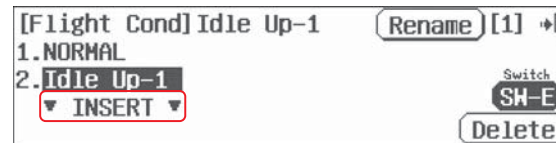

m. Press **Idle-Up-2**.

n. Press **SET**.

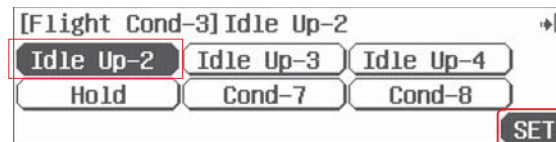

o. Select **NULL**.



FLT.COND (HELI)

p. Press **SEL**.



q. Press the **E** icon for the 3 position switch E.
r. Press the **Exit** icon.

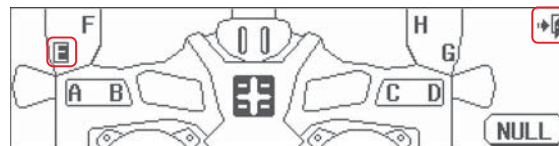

s. Move switch E forward to the [2] position.
Press the **OFF** lower position icon.

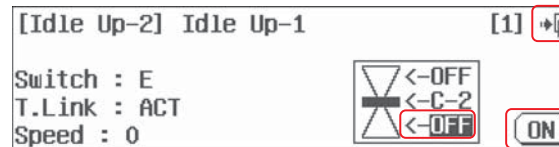

t. Press the **ON** icon.

u. Press the **Exit** icon.

We now have programmed a NORMAL, an idle-up 1, and an idle-up 2 flight condition setting on switch E. Continue with this tutorial to set the throttle hold function on switch F.

a. Press **INSERT**.

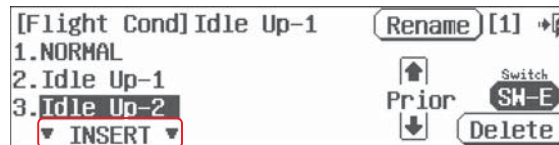

b. Press **HOLD**.

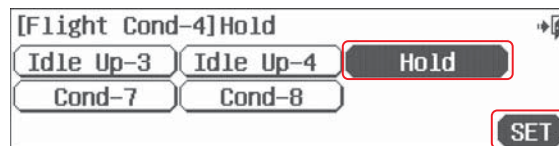

c. Select **SET**.

d. Press **NULL**.

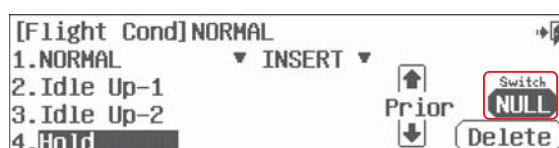

FLT.COND (HELI)

e. Press **SEL**.



f. Select the icon for switch **F**, this will be our throttle hold switch

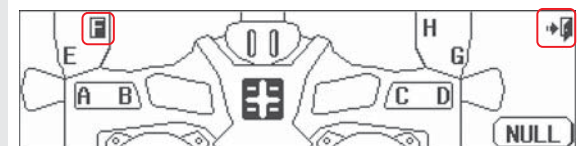

g. Press the **Exit** icon

h. Press the lower **OFF** icon on the switch graphic



i. Press the **ON** icon

j. Press the **Exit** icon twice to back into the model menu

The F switch when toggled forward is the throttle hold function

To apply a throttle hold point for the throttle, refer to throttle hold page 126.

At this point we can choose to modify the existing flight conditions we made;

1. Delete any of the flight conditions you made.
2. Renaming an existing flight condition to reflect its purpose.
3. Add more flight conditions and apply them to other switches.
4. Change the selected flight conditions priority.
5. Decide if you want the added flight conditions to have a "trim link".
6. Add a time delay to the activation of the flight conditions.

FLT.COND (HELI)

1. Delete any of the flight conditions you made.

a. Select a flight condition you wish to delete.

b. Press **Delete**.



c. Press **Yes** to delete the selected flight condition.

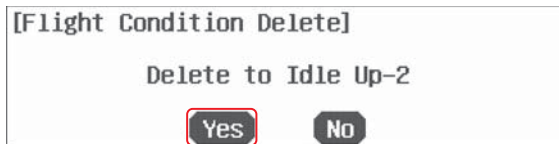

2. Renaming an existing flight condition to reflect its purpose.

a. Press **Idle Up-1**

b. Select **Rename**



c. Name the flight condition to identify it with "what it does". If for example, this flight condition is for hovering, name it "hover". Press **enter** when done.



3. Add more flight conditions and apply them to other switches.

Follow section b through k as noted previously in this section.

4. Change the selected flight conditions priority

When two or more flight conditions are programmed, you may change their priority by selecting the flight condition to change, and pressing the **arrow** on the Prior icon bar.

5. Decide if you want the added flight conditions to have a "trim link".

To fine tune the movement values of a flight condition, you may want the trim to be changeable, or to follow the other flight modes. This is done at the T.LINK: INH arrow icon. Pressing the **arrow** will toggle between INH and ACT to inhibit or activate the trim link function for the selected flight condition.



Trim link and condition speed can be adjusted on the flight condition list screen for NORMAL condition, while to change the trim link and condition activation speed is done on their respective switch select screens for all the other flight conditions.

6. Add a time delay to the activation of the flight conditions.

Most users will desire a flight condition to be smoothly applied and retracted. Adjust the condition speed with the **Speed : 0** icon using the **+RST-** icons.

FLT.COND (HELI)

C and S, Combination and Separate "movement value" set-ups.

When you have several different flight conditions set-up, as you program control surface movement values into any of the following features, you can choose to have those values be associated with the C or S icon. This means;

- The C values will work in combination with all other functions with a C value.
- The S values will work separately from the C value functions.



Applying any feature with the flight condition C or S option multiplies the capability of the Aurora dramatically. The default for all features will be the C values. As with most of the Auroras features, experimentation is encouraged as experience is truly the best teacher.

Pitch and Throttle Curves (HELI)

P. Curve and T. Curve

In the Aurora, both the pitch AND throttle curve functions are on the same menu, IF both pitch and throttle curve functions are "active". Additionally both menus are defined the same way, so to avoid repetition we will explain both throttle and pitch curve menus here.

If you have a collective pitch heli, pitch and throttle curve manipulation is mandatory to achieve the maximum performance capability from the machine.

The pitch and throttle curve functions in the Aurora allow you to modify the normally linier movement using seven different points along the curve that can accept a movement value. Exponential curve values and an acceleration feature are included within this menu.



Those wishing a "pitch hovering trim" and "throttle hovering trim" capability will find it within their respective (adjust switch menu) on page 73. More on this at the end of this section.

This function can be influenced by the flight condition feature

To activate both Pitch and Throttle curve menus;

a. Press **P.Curve** in the model menu.

b. Press **ACT** to activate the Pitch Curve menu.



c. Press the **Exit** in the upper right corner of the screen to return to the model menu.

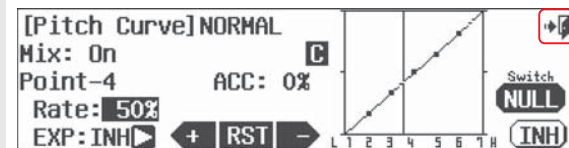

d. Press **T.Curve** in the model menu.

e. Press **ACT** to activate the throttle curve feature menu.

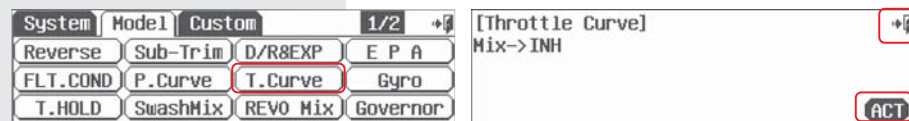

Pitch and Throttle Curves (HELI)

- f. Note the **THRO** arrow **NORMAL** line on the menu. Pressing the **arrow** will cycle you to the Throttle Curve menu.

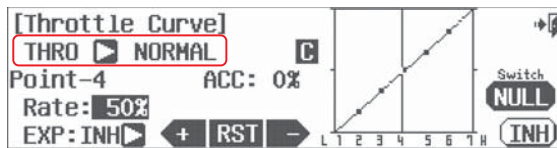

Switch Option and in flight Fine Trim Adjustment Switch Function.

- g. To select a 2 or 3 position switch that will allow you to program multiple curve values, press **NULL** and follow the switch activation process on page 68. This is also the menu to apply the hovering pitch and throttle controls to the VR switches.

Switch type	Function	VR Adjust
2 or 3 position	Multiple values	Pitch and Throttle



You don't have to set a switch to have multiple curves at this point. Many users will choose to use the flight conditions / Idle-Ups to select between different curve values as the flight condition function will also influence the gyro, governor, dual and exponential rates plus many other critical mixes and functions.

- h. Note how the throttle movement is shown on the graph, and as a percentage value as the throttle is advanced and retarded. If you wish to change one of the curve points, use the throttle to place the graph line through the point you wish to change. Use the **+RST-** icon to set a new value. Note the change in the graph curve.
- i. **INH** (turn off), or **ACT** (turn on) a point by using the throttle to place the graph line through the point you wish to change, press **RST**.
- j. Add an exponential curve from one point to another by pressing the **Arrow** next to the **EXP: INH** icon and have it switch to **EXP: ACT**. This activates the expo option between it, the prior and the next point. Use the **+RST-** icons to add a value creating a curve.
- k. Change the activation speed with the **ACC: 0%** icon, or acceleration feature. Again using the throttle to place the graph line through the point you wish to change, use the **+RST-** icons to change the acceleration value.
- l. Select the **Exit** icon to return to the model menu.

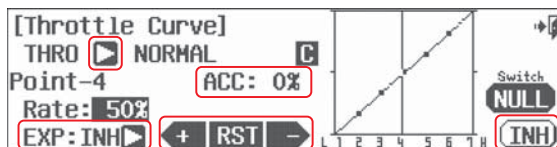

Throttle and pitch adjust feature

Program the LT, CT and RT VR switches to work as in-flight adjustment controls for 5 different throttle and pitch curve adjustment features. These adjustment menus are located in the Pitch and throttle switch set-up menus. For more detailed instruction on their use, see page 73.



Throttle curve adjust options include;

1. Hover adjust
2. Hover with pitch adjust

Pitch curve adjust options include;

1. Hover adjust
2. High pitch adjust
3. Low pitch adjust

Needle (HELI)

Carburetor Mixture Adjustment.

The Needle function is really two features; one is a manual needle adjustment independent of a mix. This is done by moving the LS slider control. The goal is to lean or richen the fuel mixture in relation to the blade pitch values. The second is a switched, automatic mix between a mixture control servo of a glow or gas heli motor, and the blade pitch.

There are two ways to activate this mix.

1. Use a slider. The default is the LS slider.
2. Direct mix to the pitch function activated with throttle stick movement.

This function can be influenced by the flight condition feature

- a. Select **Needle** from the model menu

- b. Press **ACT**.



Switch Option

- c. To select a 2 or 3 position switch that will allow you to program multiple values and apply an in-flight adjustment switch, press **NULL** and follow the switch activation process on page 68.

Switch type	Function	VR Adjustment
2 or 3 position	Multiple values	Fine tuning control choice

Direct needle control method

- d. The first feature noted is the **KNOB** control of the needle mix. Move the LS slider and see the graph line shift across the screen. Use it to highlight the H or L rate value and use the **+RST-** icon to apply a movement value.

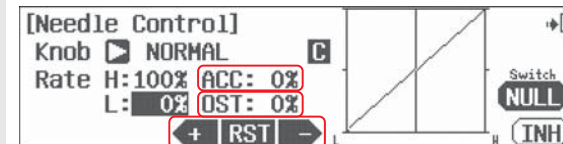

- e. Try the **ACC** feature to change the speed of the mix. Press the **ACC: 0%** icon. Experiment with positive and negative values watching the results on your model.

- f. Use the **OST: 0%** (offset) feature to manipulate the curve even more.

Mix to pitch method

- g. Here we program the rate values for high and low needle servo movement in relation to the blade pitch movement. Move the throttle stick to highlight the H or L position and use the **+RST-** icon to set a value for the high and low position.
- h. Try the **ACC** feature to change the speed of the mix. Press the **ACC: 0%** icon. Experiment with positive and negative values watching the results on your model.
- i. Use the **OST: 0%** (offset) feature to manipulate the curve even more.
- j. Select the **Exit** icon to return to the model menu.

SWH-THR (HELI)

Swash to Throttle Mix.

A swash to throttle mix is typically used to increase the throttle RPM when a swash input is given to the heli. The increased RPM compensates for loss of rotor disk lift as a result of the rotor disk tilt.

This function can be influenced by the flight condition feature

a. Select the **SWH-THR** icon in the model menu.

b. Select **ACT** to activate the feature.



Switch Option and In-Flight Fine Trim Adjustment Switch Function

c. To select a 2 or 3 position switch that will allow multiple mix values and to select an "in-flight" ADJUSTMENT switch, press **NULL** and follow the switch activation process on page 68.

Switch type	Function	VR Adjustment
2 or 3 position	Multiple values	Fine tuning control choice

d. Use the arrow icon to select the swash input, AILR or ELEV you wish to add throttle compensation for.

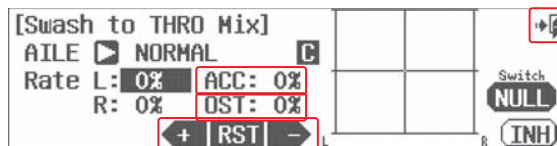

e. Move the control stick and use the **+RST-** icons to apply a travel rate for the direction of swash movement.

f. Use the **ACC** feature to change the speed of the mix. Press the **ACC : 0%** icon. Experiment with positive and negative values watching the results on your model.

g. Additional adjustment can be applied to the mix using the **Offset**, or **OST : 0%** value.

h. Repeat this process for all swash movement directions.

i. Select the **Exit** icon to return to the model menu.

RUD-THR (HELI)

Tail Rotor to Throttle Mix.

This mix is between the rudder, or tail rotor input and the throttle. It is generally used to raise or lower the throttle RPM slightly to compensate for tail rotor dynamics.

This function can be influenced by the flight condition feature

a. Select **RUD-THRO** from the model menu.

b. Press the **ACT** icon to enter the rudder to throttle mix menu screen.



Switch Option and In-Flight Fine Trim Adjustment Switch Function

c. To select a 2 or 3 position switch that will allow multiple mix values and to select an "in-flight" ADJUSTMENT switch, press **NULL** and follow the switch activation process on page 68.

Switch type	Function	VR adjustment
2 or 3 position	Multiple values	Fine tuning control choice

d. Move the rudder stick side to side to highlight the rate value you want to adjust.

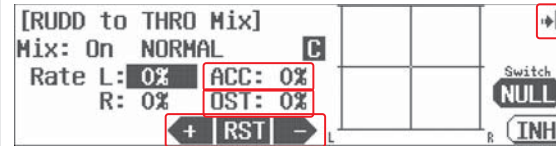

e. Use the **+RST-** icons to add a throttle value for each side of the rudder movement input. Note how the throttle input movement values are shown on the graph.

f. Use the **ACC** feature to change the speed of the mix. Press the **ACC : 0%** icon. Experiment with positive and negative values watching the results on your model.

g. Additional adjustment can be applied to the mix using the **Offset**, or **OST : 0%** value.

h. Press the **Exit** icon to exit back to the model menu.

T. HOLD (HELI)

Throttle Hold Position

Throttle hold is used to set the throttle at a programmed position when throttle hold is selected. This Function is often used to facilitate auto rotation maneuvers.

This function can be influenced by the flight condition feature

To use the Auroras throttle hold feature; In our tutorial, we placed the hold switch on F.



The throttle hold feature will not work unless a hold position has been assigned a switch using the flight condition/idle-up function as was done on page 118 and 119.

a. Select **T.HOLD** from the model menu. T.Hold activation screen

b. Press **ACT** to activate the throttle hold menu.



At this point we can select a switch to place multiple hold positions on. However it is not necessary at this point, this can be done later through the switch menu, if you wish.

c. Press the **Rate1 : 0%** icon.

d. Use the **+RST-** icons to place a rate value for the hold position you want the throttle to be at when the hold switch is activated.

e. To set an activation delay, press the **Delay: 0** icon and set a value with the **+RST-** icons.

f. Press the **Exit** to return to the model menu.



Explorer the throttle cut position adjustment as show on page 75 and the (link to trim) selection as show on page 74.

Swash Mix (HELI)

Swash Plate Adjustment Menu.

Use the swash mix feature to apply a fine adjustment to the swash plate travel. For the very best accuracy, we recommend the use of a swash plate leveling set-up tool.



As this is a set-up feature, swash mix is one of the few functions that is NOT influenced by flight conditions, idle-up or hold conditions.

Our example will show a 120CCPM head format.

a. Select **SwashMix** from the model menu.

b. From this screen we can set a travel rate for the individual collective servos using the **+RST-** icon.



c. We can also reverse the direction of the collective input with the **REV** icon.

d Are you sure? Press **Yes**, or **No**.

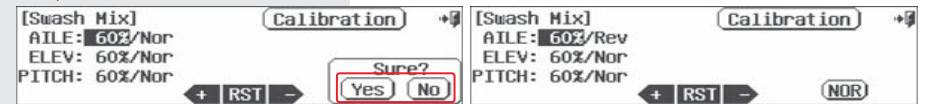

* For most users this degree of swash accuracy is appropriate. To further adjust the swash, consult the next menu, calibration.

Calibration menu

The use of a swash leveling tool is mandatory for the super fine adjustment provided in this menu.

e. Select the **Calibration** icon



f. From this intermediate menu, select the function to adjust. For our example select **Pitch**.



g. Select **ACT** Pitch calibration menu



Swash Mix (HELI)

h. In this menu, we can modify the inputs of both the aileron and elevator in relation to the pitch function.

i. Select the AILE arrow to cycle to the ELEV, or elevator menu.

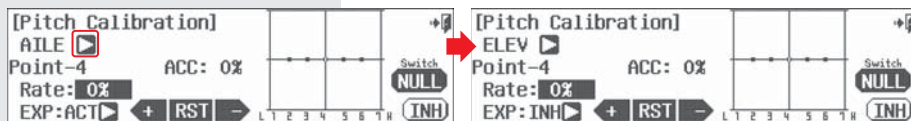

j. Move the elevator stick up and down to note the way it slides against the graph of the pitch line (the horizontal line in the middle with the little dots). Move the elevator stick over a dot to change the rate value with the +RST- icon.

k. Inhibit (turn off), or activate (turn on) a point by using the throttle to place the graph line through the point you wish to change, press RST.

l. Add an exponential curve from one point to another by pressing the arrow next to the EXP: INH icon and have it switch to EXP: ACT. This activates the expo option between it, the prior and the next point.

m. Use the +RST- icons to add a value creating a curve.

n. Change the activation speed with the ACC: 0% icon, or acceleration feature. Again using the throttle to place the graph line through the point you wish to change, use the +RST- icons to change the acceleration value.

Switch Option

o. To select a 2 or 3 position switch that will allow multiple mix values, press NULL and follow the switch activation process on page 68.

Switch type	Function
2 or 3 position	Multiple values

p. When you are done programming the aileron and elevator controls on this screen, select the Exit icon to return to the swash calibration servo select menu.

q. Adjust the features of all the collective servos as necessary to achieve the desired swash movement effect.

r. Select th Exit icon twice to access the model menu.

REVO Mix (HELI)

Revolution Mix.

Revo, or revolution mixing is used to dampen the torque created by the main rotor speed and pitch variations during flight.



Revo mix is not used when a modern heading hold gyro is installed in the heli. The heading hold function of the gyro will correct the issue.

This function can be influenced by the flight condition feature

a. Select REVO Mix from model menu.

b. Press ACT to activate the REVO Mix menu.

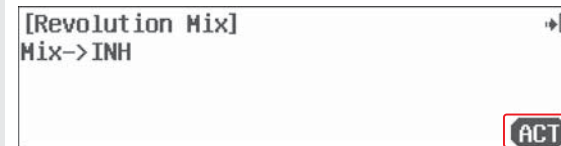

Switch Option

c. To select a 2 or 3 position switch that will allow multiple values, press NULL and follow the switch activation process on page 68.

Switch type	Function
2 or 3 position	Multiple values

d. The default rate for the mix is 30%. Change the value by lowering and raising the throttle to highlight the high or low positions.

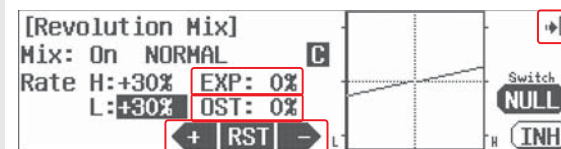

e. Change the value with the +RST- icon. Note how the mix movement changes are shown on the graph.

f. To fine tune the input of the throttle input, apply a value with the exponential function shown as EXP: 0%.

g. Additional adjustment can be applied to the mix using the Offset, or OST: 0% value.

h. Press the Exit icon to exit back to the model menu.

Gyro (HELI)

Gyro on/off and Sensitivity Adjustment.

Almost all modern helicopters use a gyro on the tail rotor control. The Aurora offers you the ability to use a switch to have three different gyro “rates” per flight condition or “idle-up” and hold condition.

There are dozens of manufacturers creating a hundred gyro models. To effectively set-up the gyro function you should have the gyro manufacturer’s instruction manual available to you.

We will discuss the two main types of gyros, single and dual rate.

This function can be influenced by the flight condition feature

Gyro set-up for helis

a. Select **Gyro** from the model menu.

b. Press **ACT** to activate the gyro menu.



Without selecting a gyro switch option, you will have one rate option in each flight condition or idle-up and hold settings. If you choose to set the gyro function on a switch, you can have a different rate value for each switch position, in each different flight condition or idle-up and hold condition.

We will keep it simple, and not select a multiple value switch for the gyro at this point. You can do it later if you wish.

Single rate gyro set-up

c. The default sensitivity value is 50%. According to the gyro manufacturer’s guidelines, apply an appropriate % value with the **+RST-** icons for each different idle-up and hold condition you have set.



Dual rate gyro set-up

d. Many modern gyros are, dual rate heading hold products. To use a dual rate gyro select the Mode: Single arrow to change it to, Mode: Dual and press Yes when asked “Sure?”



e. Consult the gyro manufacturer’s documentation to determine what rate value should be applied. Use the **+RST-** icon to apply a rate % value for each idle-up and hold condition.

f. On the, Rate1: 0%/NOR arrow line, press the arrow to cycle between a normal and Tlock or throttle lock feature. This is used for bench testing the gyro rate sensitivity.

g. Select the **Exit** icon to return to the model menu.

Gyro (HELI)



Note

- Most single rate gyro’s will be in a heading lock mode with the rate values at or above 50%. A rate value below 50% is used for a “non-heading lock” or “rate” setting.
- Explorer the “adjust” function in the switch menu to apply an in-flight adjustment switch to fine tune your heli gyro setting.
- Be sure to set a rate value for each different idle-up and hold condition you have programmed. Note the C and S feature and how they might be used.

Switch Option

As noted previously in the gyro instructions, if you want to have a switch that offers a different rate value for each switch position. See page 68 for the switch selection process instructions.

Governor (HELI)

RPM Governor Device Menu.

The Aurora features up to three Governor and switch control rate values per model memory.

This function can be influenced by the flight condition feature



Note

To effectively set-up the governor function, you should have the governor manufacturer’s instruction manual available to you.

a. Select **Governor** from the model menu. Governor activation screen

b. Press **ACT** to activate the governor menu. Governor screen



Tip

Without selecting a switch option, the governor rate can be different for all flight conditions or idle-up and hold settings. If you choose to set the governor function on a switch, you can have a different rate value for each switch position, and the screen will reflect this with a rate value option for rate 1, rate 2 or rate 3. To simplify this example we will set the governor up without a switch.

Unit of Value, RPM or %

a. There are two Units of Value in the governor menu. Change the “Unit of value” for the governor display menu screen to either RPM value or % values by pressing the Unit: % arrow icon to cycle between RPM and %. Unless your governor manufacturer specifically calls for the RPM value, we suggest you use the % value.

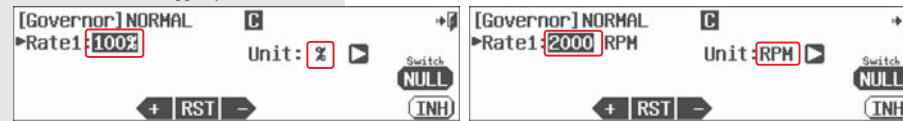

Governor (HELI)

% Unit of Value operation

b. The default sensitivity value is 50% (1500RPM) and the Maxium value is 110%(2100 RPM). According to the governor manufactures guidelines, apply an appropriate % value with the + RST - icons. Set a rate value for all your idle-up and hold switch positions.

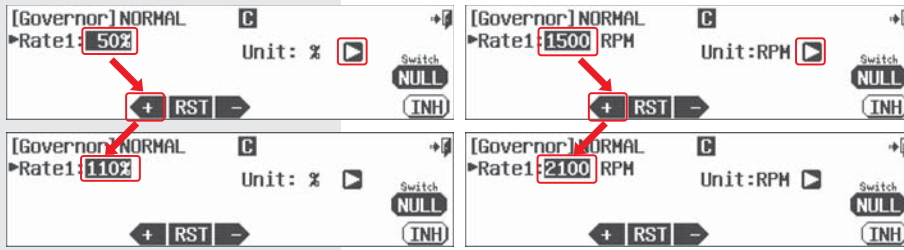

Switch Option

c. As noted previously in the governor instructions, we can choose a two or three position switch to apply multiple rate values. See page 68 for the switch selection process.

Switch type	Function	VR adjustment
2 or 3 position	Multiple values	Fine tuning control choice

d. Select the Exit icon to return to the model menu.



- Explorer the "adjust" function in the switch menu to apply an in-flight adjustment switch to fine tune your heli governor setting.
- Be sure to set a rate value for each different idle-up and hold condition you have programmed. Note the C and S feature and how they might be used.