

X2 HIGH POWER



HiTEC

OPERATION MANUAL

WARNING: THE CHARGING AND DISCHARGING OF RC HOBBY BATTERIES CAN BE DANGEROUS. FAILURE TO FOLLOW THE INSTRUCTIONS AND WARNINGS IN THIS MANUAL MAY RESULT IN PROPERTY DAMAGE AND/OR LOSS OF LIFE.

Table of Contents

Table of Contents:

Introduction	03
Warning and Safety Notes	04
Product Layout	08
Specifications	09
Features	10
Battery & Power Supply Connections	12
Power Distribution	13
Operation	14
Program Flow Chart	15
Charger Operation	16
Lithium Battery Program [LiPO/LiHV/LiFe/Lilon]	17
NiMH/NiCd Battery Program	25
Pb Lead-Acid Battery Program	29
Battery Meter	32
Battery Resistance Meter	33
Memory Preset - Data Store/Load	34
Advanced System Set Up	36
Warning and Error Messages	38
Using the Charge Control Software [CHARGE MASTER]	39
Recommended Accessory	39
Commonly Used Terms	40
Conformity Declarations	41
Disposal and Prop 65 Warning	42
Warranty and Service	42

Introduction

Congratulations on purchasing your new X2 High Power Charger! This latest addition to our innovative charger line offers expanded capacity and compatibility in a portable and compact package. With dual inputs affording flexible battery charging at home and in the field, the X2 High Power also boasts Hitec's innovative power distribution mode which allows you to efficiently assign output power based on individual battery requirements, as well as being able to distribute power to a DC output port to power even more devices. Capable of charging all battery chemistries (including the new generation LiHV), this powerhouse has a built in 250 Watt power supply, internal balancing circuits and 10 different charge/discharge profiles. The X2 High Power also features a highly unique and innovative Voice Guide function which will help you program your charger to give you a charger that is unmatched in performance capability.

As with all Hitec products, please read the OPERATING INSTRUCTIONS, WARNING and SAFETY NOTES in their entirety before you attempt to use your new product.



THE CHARGING AND DISCHARGING OF RC HOBBY BATTERIES CAN BE DANGEROUS. FAILURE TO FOLLOW THESE EXPLICIT WARNINGS CAN

Warning RESULT IN PROPERTY DAMAGE AND/OR LOSS OF LIFE.

- ⚠ NEVER LEAVE YOUR CHARGER UNATTENDED WHILE IN OPERATION.
- ⚠ NEVER CHARGE ON OR AROUND COMBUSTIBLE MATERIALS.
- ⚠ NEVER CHARGE A DAMAGED BATTERY PACK.
- ⚠ LOW COST, NO-NAME BATTERY PACKS POSE THE MOST DANGER. WE RECOMMEND YOU ONLY USE BATTERY PACKS THAT ARE SOLD AND WARRANTIED BY A REPUTABLE COMPANY.
- ⚠ IT IS HIGHLY RECOMMENDED THAT YOU UTILIZE A SAFETY DEVICE SUCH AS A STEEL CASE OR LIPO SACK™ WHILE CHARGING LITHIUM CHEMISTRY BATTERIES.
- ⚠ IT IS HIGHLY RECOMMENDED THAT YOU KEEP AN OPERABLE "CLASS A" FIRE EXTINGUISHER IN THE CHARGING AREA.



FAILURE TO FOLLOW THESE WARNINGS CAN BE CONSIDERED NEGLIGENCE BY THE OPERATOR AND MAY NEGATE ANY CLAIMS

Warning FOR DAMAGES INCURRED.

Hitec RCD USA will not be held responsible for any damages or injuries that may

Warning and Safety Notes

occur by persons who fail to follow these warnings or who fail to properly follow the instructions in this manual.



Warning



Tip

Warning: Be sure to read this section for your own safety.

Caution: Be sure to read this section to prevent accidents and damage to your charger.



Note



Caution

Tip: This section will help you maximize the performance of your charger.

Note: This section will provide more detailed explanations.

These warnings and safety notes are of the utmost importance. You must follow these instructions for maximum safety. Failure to do so can damage the charger and the battery and in the worst cases, may cause a fire.



Warning

NEVER LEAVE THE CHARGER UNATTENDED WHILE IT IS CONNECTED TO ITS POWER SOURCE. IF ANY MALFUNCTION IS FOUND, TERMINATE THE PROCESS AT ONCE AND REFER TO THE OPERATION MANUAL.

- ⚠ The allowable DC input voltage is 11-18V DC.
- ⚠ The allowable AC input voltage is 100-240V AC.
- ⚠ Keep the charger away from dust, damp, rain, heat, direct sunlight and excessive vibration.
- ⚠ If the charger is dropped or suffers any type of impact, it should be inspected by an authorized service station before using it again.
- ⚠ This charger and the battery should be put on a heat-resistant, non-flammable and non-conductive surface.
- ⚠ Never place a charger on a car seat, carpet or similar surface. Keep all flammable, volatile materials away from the operating area.
- ⚠ Make sure you know the specifications of the battery to be charged or discharged to ensure it meets the requirements of this charger. If the program is set up incorrectly, the battery and charger can be damaged.
- ⚠ Fire or explosion can occur due to overcharging.

Warning and Safety Notes [cont.]

- ⚠ To avoid a short circuit between the charge lead, always connect the charge cable to the charger first, then connect the battery. Reverse the sequence when disconnecting.
- ⚠ Never attempt to charge or discharge the following types of batteries:
 - A battery fitted with an integral charge circuit or a protection circuit
 - A battery pack which consists of different types of cells (including different manufacturer's cells)
 - A battery that is already fully charged or just slightly discharged and non-rechargeable batteries (these pose an explosion hazard)
 - A faulty or damaged battery
 - Batteries installed in a device or which are electrically linked to other components
 - Batteries that are not expressly stated by the manufacturer to be suitable for the currents the charger delivers during the charge process

PLEASE BEAR IN MIND THE FOLLOWING POINTS BEFORE YOU COMMENCE CHARGING:

- Did you select the appropriate program suitable for the type of battery you are charging?
- Did you set up the adequate current for charging or discharging?
- Have you checked the battery voltage? Lithium battery packs can be wired in parallel and in series, i.e. a 2-cell pack can be 3.7V (in parallel) or 7.4V (in series).
- Have you checked that all connections are firm and secure?
- Make sure there are no intermittent contacts at any point in the circuit.

Warning and Safety Notes [cont.]

Standard Battery Parameters

	LiPo	LiHV	Lilon	LiFe	NiCd	NiMH	Pb
Nominal Voltage	3.7V/cell	3.8V/cell	3.6V/cell	3.3V/cell	1.2V/cell	1.2V/cell	2.0V/cell
Max. Charge Voltage	4.2V/cell	4.35V/cell	4.1V/cell	3.6V/cell	1.5V/cell	1.5V/cell	2.46V/cell
Storage Voltage	3.8V/cell	3.85V/cell	3.7V/cell	3.3V/cell	n/a	n/a	n/a
Allowable Fast Charge	≤ 1C	≤ 1C	≤ 1C	≤ 4C	≤ 1-2C	≤ 1-2C	≤ .04C
Min. Discharge Voltage	3.0-3.3V/cell	3.1-3.4V/cell	2.9-3.2V/cell	2.6-2.9V/cell	0.1-1.1V/cell	0.1-1.1V/cell	1.8V/cell



Warning

WHEN ADJUSTING YOUR X2 HIGH POWER CHARGING PARAMETERS, BE SURE YOU SELECT THE PROPER BATTERY TYPE AND CELL VOLTAGE FOR THE TYPE OF CELL YOU ARE CHARGING. CHARGING BATTERIES WITH THE WRONG SETTINGS MAY CAUSE THE CELLS TO BURST, CATCH FIRE OR EXPLODE.

Charging

Before charging your batteries, it is critical that you determine the maximum allowable charge rate for your batteries. The X2 High Power is capable of charging at high rates that may not be suitable or safe for your particular batteries. For example, Lithium cells are typically safe to charge at 1C, or the total mAh ÷ 1000. A 1200mAh battery would have a 1C charge rate of 1.2 amps. A 4200mAh battery would have a 1C charge rate of 4.2 amps. Some manufacturers are offering Lithium cells that can be charged at greater than 1C but this should ALWAYS be verified before charging a Lithium battery at rates higher than 1C. Voltage is just as critical as the charging amperage rate and this is determined by the number of cells in series, or "S". For example, a 3S LiPo is rated at 11.1 volts ("S" multiplied by a single LiPo cell with a nominal voltage of 3.7 volts DC. 3 cells x 3.7 volts each equals 11.1 volts DC).

Connect the battery's main leads to the charger output: red is positive and black is negative. Keep in mind that the gauge or thickness of your charging leads from the X2 High Power to your battery must be of an acceptable current rating to handle the applied charge current. For maximum safety and charging effectiveness, always match or exceed the main battery lead rating when assembling or selecting your charging leads. If you charge a battery at a high current rate (amperage) with a charging lead not rated for the chosen amperage, the wire could get hot, catch fire, short out and/or potentially destroy your battery and the charger.

Warning and Safety Notes [cont.]

When in doubt, always use a higher gauge wire (lower AWG number). It is common to see charging leads constructed of 14AWG, 16AWG or 18AWG wire.

Always refer to recommendations from your battery manufacturer for your specific battery type and size before initiating a charge or discharge process.

Do not attempt to disassemble or modify Lithium or Lead-Acid battery packs.

Discharging

The X2 High Power discharging functions are for two specific purposes:

- Refreshing the capacity of a Nickel-based battery that has lost capacity over time (NiMH or NiCd).
- Reducing the voltage of a Lithium battery for safe storage.



Note

LITHIUM CHEMISTRY BATTERY PACKS SHOULD ONLY BE DISCHARGED TO THEIR MINIMUM SAFE VOLTAGE, NO LOWER. DEEP DISCHARGING A LITHIUM CELL WILL DO PERMANENT DAMAGE. REFER TO THE STANDARD BATTERY PARAMETERS TABLE ON PAGE 6 OF THIS MANUAL FOR MINIMUM DISCHARGE VOLTAGES.

LiPo & LiHV Charge/Discharge Cycling

Lithium batteries are known to reach full capacity after a break-in period of about 10 charge/discharge cycles. We do not recommend you use the X2 High Power charger to do this; normal use and recharging will achieve the same results. If you wish to perform a Lithium break-in on the bench with the X2 High Power, discharging to minimum acceptable voltages and performing a balance charge at 1C maximum rate is recommended. If you choose to break in your Lithium batteries under normal use, charging at only 1C for the first ten cycles will help ensure full performance and service life from your Lithium cells.

Error Codes

In the case of an error, the screen will communicate the cause of the error and emit an audible sound. The descriptions for these errors can be found on the

Warning and Error Messages page.

Product Layout

The Set Contains:

- 1 1 x X2 High Power Charger
- 2 2 x XH Adaptor
- 3 2 x Charging Cables w/ Dean Connectors
- 4 2 x Charging Cables w/ XT-60 Connectors
- 5 Power Cord



RIGHT SIDE

- 1 Cooling Fan
- 2 DC Input 11-18V/DC Output 13.8V
- 3 DC Output Power Level Indicator
- 4 Micro USB Port for PC Link
- 5 Resume or Start Charge Processes
- 6 Adjust Values / See the Status of Individual Cells in Balance Charge Mode
- 7 Scroll through the Main Menu / Stop Any Charge Processes



LEFT SIDE

- 1 AC Socket 100-240V
- 2 Power Switch
- 3 Output Socket 4mm Banana Plug
- 4 Balance Lead Socket
- 5 Temperature Sensor Port
- 6 USB Port
- 7 LCD Display

Specifications

X2 High Power Specifications	
AC Input	100 - 240 Volts AC
DC Input	11 - 18 Volts DC
Charge Circuit Power (CH1 + CH2 + PS = 250W)	Channel 1: 50 - 120 Watts AC input
	Channel 2: 50 - 120 Watts AC input
	10 - 150 Watts DC Output
Charge Current Range	0.1 - 10.0 Amps x 2
Discharge Current Range	0.1 - 2.0 Amps x 2
Discharge Current Power	10 Watts x 2
Current Drain for LiPo Balancing	300mA per cell
NiCd/NiMH Battery Cell Count	1 - 15 Cells
- Capacity Range	100 - 50000mAh
LiPo/LiHV/LiFe/LiIon Cell Count	1 - 6 Cells
- Capacity Range	100 - 50,000mAh
Pb Battery Voltage	2 - 20 Volts
- Capacity Range	100 - 50,000mAh
Net Weight	2.85 lbs
	1293g
Dimensions	7.24 x 5.74 x 2.75 in
	184 x 146 x 70mm

Features

Dual Input and Power Distribution:

The X2 High Power has a dual AC/DC input comprised of AC 100-240V and DC 11-18V. In DC mode, the power of each channel is 120W with an overall power of 240W. Power distribution is supported in AC mode, with the ability to power other DC powered devices using the chargers built-in DC output power supply.

Optimized Operating Software:

The X2 High Power features the latest in innovative microprocessor controlled charging software to help aid end users in charging their batteries safely and effectively. It can also disconnect the circuit automatically and sound an alarm if an abnormal reaction has been detected. Each programming feature of your X2 High Power is controlled by two way linkage and communication and is completely customizable to the user's preferences.

Battery Memory (Data Store/Load):

The charger can store up to 10 unique charge/discharge profiles for each channel and lets you recall the data from each program setting at any time.

Terminal Voltage Control(TVC):

For experienced users, the charger's end voltage can be reset.

Internal Independent Lithium Battery Balancer:

Hitec's X2 High Power employs an individual cell-voltage balancer built into the unit. It is not necessary to connect an external balancer for balance charging.

Features [cont.]

Re-Peak Mode of NiMH/NiCd Battery:

In re-peak charge mode, the charger can peak charge the battery once, twice, or three times in a row automatically. This function is useful for ensuring a full battery charge.

Delta-Peak Sensitivity for NiMH/NiCd:

This automatic charge termination program is based on the principle of the Delta-peak voltage detection. When the battery's voltage exceeds the threshold, the process will be terminated automatically.

Cyclic Charging/Discharging:

1 to 5 cyclic and continuous charge > discharge or discharge > charge sessions are optimal for battery performance and balancing.

Automatic Charging Current Limit:

You can set the upper limit of the charging current when charging your NiMH or NiCd battery. The 'AUTO' charging mode, however, is recommended when charging NiMH batteries with low impedance and capacity.

LiPo Battery Meter:

The user can check the battery's total voltage, the highest voltage, the lowest voltage and the voltage of each cell.

Battery Internal Resistance Meter:

The user can check the battery's total internal resistance and the internal resistance of each cell.

Capacity Limit:

The charging capacity is always calculated as the charging current multiplied by time. If the charging capacity exceeds the limit, the process will automatically terminate according to the maximum value previously set.

Temperature Threshold*:

The battery's internal chemical reaction will cause the temperature of the battery to rise. If the temperature limit is reached, the process will be terminated.

* This function is available by connecting an optional temperature probe which is available as a separate purchase.

Processing Time Limit:

Protect your battery by setting a maximum time limit for charging and discharging.

Battery & Power Supply Connections



Warning

TO AVOID SHORT CIRCUITS, ALWAYS CONNECT THE CHARGE LEADS TO THE CHARGER FIRST, AND THEN TO THE BATTERY. REVERSE THE SEQUENCE WHEN DISCONNECTING THE PACK.

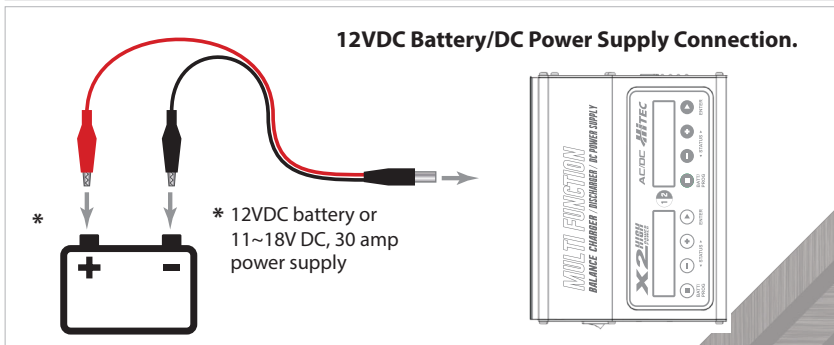
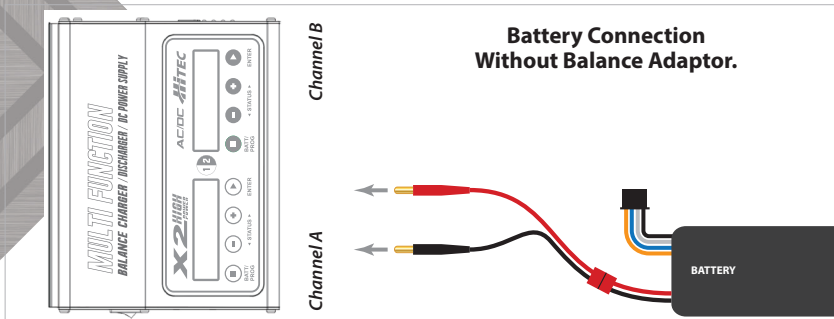
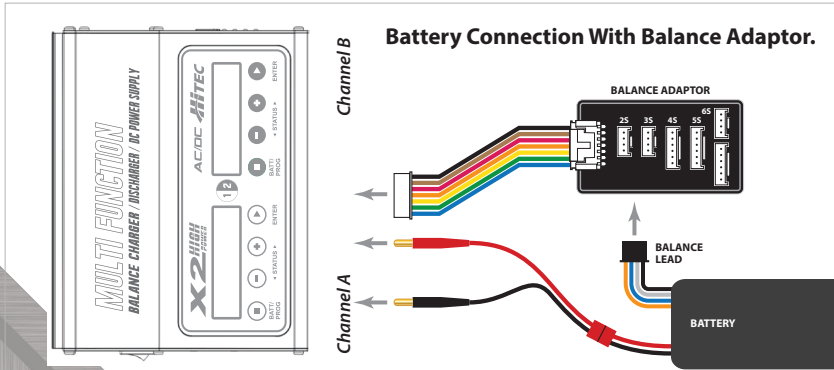

Power Distribution

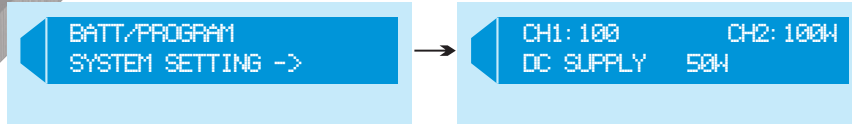

Powered by AC Household Current: In AC mode, the X2 High Power has a maximum charging output of 240 watts total. This charge output can be allocated differently to the DC power to provide more or less charging power.

To adjust the wattage between the channels, go to the BATT/PROGRAM menu and use the INC. – or DEC + buttons to get to the SYSTEM SETTINGS menu, press ENTER/Start to enter the SYSTEM SETTINGS menu and use the – or + buttons to scroll to the AC/DC Max Power Set screen. Press ENTER/Start and the wattage amount will begin to blink on CH1, press ENTER/Start again to change the wattage output for CH2. Use the – or + buttons to adjust the wattage for the channel you have selected.



Note

Adjusting one or both channels will change the DC port output power, I.E. if you change both CH1 and CH2 to 120w the DC power will automatically change to 10 watts. If you change CH1 to 70 watts and CH2 to 100 watts then the DC port will automatically change to 80 watts.

Powered by Automotive Battery or DC Power Supply: The DC power output port is used as the DC power input port when used with an external DC power source or 12-volt car battery. When used in this mode, the X2 High Power has a maximum charging output of 300 watts.

NOTE: It is extremely important that you use either a fully charged 12-volt car battery or a high-quality AC/DC power supply with an output voltage range in the 11-18V DC range and a minimum output power of 300W or higher to ensure a reliable performance.

Operation

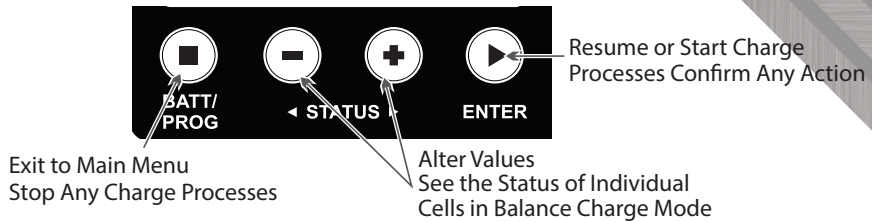

BATT PROG / STOP Button:

Stop a function in-progress or to go back to previous step/screen.

DEC Button:

Scroll through menus or decrease the parameter value.

INC Button:

Scroll through the menus or increase the parameter value.

ENTER / START Button:

Enter parameters or store parameters on-screen.

When changing a parameter value in the program, press the START/ENTER button to make it blink, then change the value by pressing the DEC and INC button. The value will be stored by repressing the START/ENTER button. If there is a second parameter to edit on the same screen, it will begin blinking after you confirm the first parameter value.

When you power the charger on, it will automatically enter the LiPo Battery balance program screen. You can change the mode (balance mode, normal charge mode, fast charge mode, store mode, or discharge mode), enter the desired charging/discharging mode, or set the preferred parameter to begin. If there are no changes to make in the LiPo Battery program, press the BATT PROG/STOP button to enter the BATT PROGRAM screen.

Program Flow Chart



The flow chart depicts one channel as the example for both channels. Channel A and Channel B are identical.

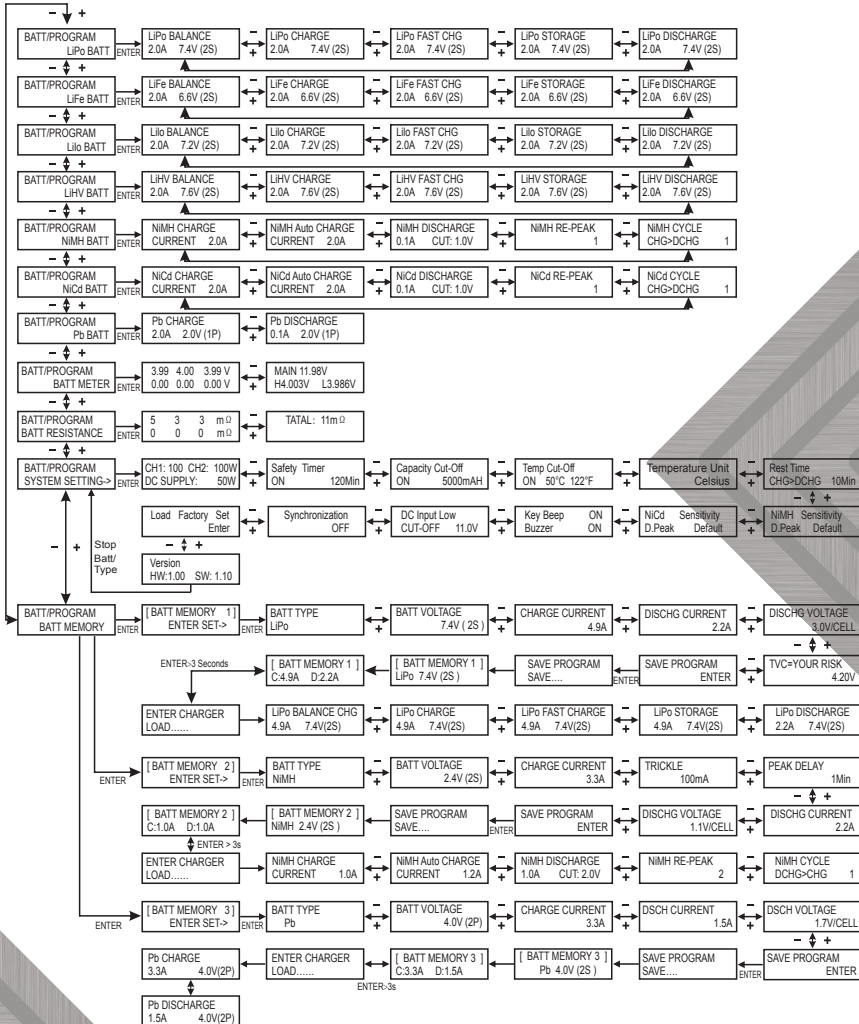

For larger version visit www.hitecrd.com

Charger Operation

The following section contains detailed procedures that must be followed to make the charger work. When you power the charger on, it will automatically enter the LiPo Battery balance program screen. Use the BATT PROG/STOP button to exit back to the BATT PROGRAM screen, or push ENTER/Start to continue. Once in the Battery Programming section use the < or > to select the desired battery or function then press ENTER/Start to make your parameter adjustments. The X2 AC High Power is capable of the following processes based on the type of battery chosen.

Batt Type	Operation Program	Description
LiPo Lilon LiFe LiHV	CHARGE	This charging mode is for charging LiPo/LiFe/Lilon/LiHV battery in normal mode.
	DISCHARGE	This mode is for discharging LiPo/LiFe/Lilon/LiHV battery.
	STORAGE	This program is for charging or discharging lithium battery which will not be used for long time.
	FAST CHG	The charging capacity may be less than normal charging but the process time will be reduced.
	BAL CHARGE	This mode is for balancing the voltage of lithium-polymer battery cells while charging
NiMH NiCd	CHARGE	The charger will charge NiMH and NiCd batteries using the charge current set by the user.
	AUTO CHG	In this program, the charger detects the condition of the battery which is connected to the output and automatically charges the battery. <i>Note: You should set up the upper limit of the charge current to avoid damage by excessive feeding current. Some batteries of low resistance and capacity can lead to higher current.</i>
	DISCHARGE	This mode is for discharging NiMH/NiCd battery.
	RE-PEAK	In re-peak charge mode, the charger can peak charge the battery once, twice or three times in a row automatically. This is good for confirming the battery is fully charged, and for checking how well the battery receives fast charges.
	CYCLE	1 to 5 cyclic and continuous process of charge>discharge or discharge>charge is operable for battery refreshing and balancing to stimulate the battery's activity.
Pb	CHARGE	This mode is for charging Pb battery.
	DISCHARGE	This mode is for discharging Pb battery.

Lithium Battery Program [LiPo/LiHV/LiFe/Lilon]

Lithium:

This program is only suitable for charging/discharging Lithium chemistry batteries (LiPo, LiHV, Lilon and LiFe).

The X2 High Power offers the following lithium charge modes: Charge, Balance Charge, Fast Charge, Storage and Discharge.



Warning

BEFORE SELECTING A CHARGE MODE, IT IS CRITICAL THAT YOU SELECT THE CORRECT TYPE OF LITHIUM BATTERY TO BE CHARGED. FAILURE TO DO SO CAN RESULT IN DAMAGE TO THE BATTERY AND POSSIBLE EXPLOSION.

Selecting a Lithium Battery Type:

BATT/PROGRAM
LiPo BATT

From the "BATT/PROGRAM" screen, press the INC. – or DEC + button to scroll through the battery type selections. Once you have selected the correct battery type, press the ENTER/Start ► button to enter the charge/discharge menu.

Lithium Charge Mode:



Warning

BEFORE YOU BEGIN CHARGING YOUR BATTERY, MAKE SURE YOU HAVE READ AND UNDERSTAND ALL OF THE WARNINGS AND SAFETY INFORMATION CONTAINED ON PAGES 2 - 7.



Note

IN THE CHARGE MODE, LITHIUM BATTERIES CAN BE CHARGED WITHOUT THE USE OF A BALANCE ADAPTOR. A BALANCE ADAPTOR CAN BE USED, BUT IT IS NOT REQUIRED. BALANCE CHARGE MODE IS RECOMMENDED FOR ANY BATTERY WITH A BALANCE LEAD.

See page 12 for the appropriate charging connections setup for this operation.

First, select the correct battery type by following the instructions on page 16. Once you have set the correct battery type, press the ► button once to enter the charge mode and battery settings screen, use the INC. – or DEC + to select "CHARGE" mode. Press the ► button again and the amp rate value will begin flashing. Use the + or – buttons to adjust the value to the desired rate. Follow the instructions provided with your battery when setting the charge amperage rate.

LiPo Charge
2.7A 11.1V (3S)

Press the ► button again and the voltage value will begin flashing. Use the + or – buttons to adjust the value to the desired rate. The voltage and cell count should match the values listed on the battery label.

Lithium Battery Program [LiPO/LiHV/LiFe/Lilon cont.]

R: 3SE R: S: 3SER
CANCEL(STOP)

R: 3SE R: S: 3SER
CONFIRM(ENTER)

You are now ready to begin charging. Press and hold the ENTER/Start ► button until you see "BATTERY CHECK", followed by the "CONFIRM (ENTER) / CANCEL(STOP)" screen. This screen displays the number of cells you set up as "R" and the number of cells detected by the processor as "S". If both numbers are identical, you may press and hold the ENTER/Start ► button to confirm and begin charging. If these numbers do not match, press the BATT/PROG Stop ■ button to return to the previous screen and carefully check the number of cells of the battery pack before proceeding.



Caution

DURING CHARGING/DISCHARGING, THE BATTERY SHOULD BE PLACED INSIDE A FIRE PROOF/RETARDANT BAG AND ON A FIRE PROOF SURFACE AWAY FROM OTHER COMBUSTIBLE OBJECTS.

LP3s 2.7A 11.88V
CHG 005: 39 00256

Once charging has commenced, the charger will display the following real-time information: battery type/cell count, charging current, battery voltage, charging time and charged capacity.

4.07 4.06 4.11V
0.00 0.00 0.00V

If you are using a balance adaptor during charging, you may press the + button to view the voltage of each individual cell.

Once the battery is fully charged, the screen will read "FINISHED" and the charger will emit a chiming sound. Press the ■ button to stop charging. You may also press the ■ button at any time during the charging process to stop charging.

Lithium Balance Charge Mode:

This function is for balancing the voltage of individual Lithium-polymer battery cells while charging. In order to use the Balance Mode, the battery must have a balance lead. Charging in this mode is different from the normal modes because the built-in processor monitors the voltage of each individual cell and controls the discharge of each individual cell in order to equalize the voltage. Use of a balance adaptor with any battery that has a balance lead will improve the performance and lifespan of your battery.



Warning

BEFORE YOU BEGIN CHARGING YOUR BATTERY, MAKE SURE YOU HAVE READ AND UNDERSTAND ALL OF THE WARNINGS AND SAFETY INFORMATION CONTAINED ON PAGES 2 - 7.

Lithium Battery Program [LiPo/LiHV/LiFe/Lilon cont.]

See page 12 for the appropriate charging connections setup for this operation.

LiPo BALANCE
2.7A 11.1V (3S) First, select the correct battery type by following the instructions on page 16. Once you have set the correct battery type, press the ► button once to enter the charge mode and battery settings screen, use the INC. – or DEC + to select “BALANCE” mode. Press the ► button again and the amp rate value will begin flashing. Use the + or – buttons to adjust the value to the desired rate. Follow the instructions provided with your battery when setting the charge amperage rate.

Press the ► button again and the voltage value will begin flashing. Use the + or – buttons to adjust the value to the desired rate. The voltage and cell count should match the values listed on the battery label.

R: 3SE R S: 3SER
CANCEL(STOP) You are now ready to begin charging. Press and hold the ENTER/Start ► button until you see “BATTERY CHECK.” followed by the “CONFIRM (ENTER) / CANCEL(STOP)” screen. This screen displays the number of cells you set up as “R” and the number of cells detected by the processor as “S”. If both numbers are identical, you may press and hold the ENTER/Start ► button to confirm and begin charging. If these numbers do not match, press the BATT/PROG Stop ■ button to return to the previous screen and carefully check the number of cells of the battery pack before proceeding.



Caution

DURING CHARGING/DISCHARGING, THE BATTERY SHOULD BE PLACED INSIDE A FIRE PROOF/RETARDANT BAG AND ON A FIRE PROOF SURFACE AWAY FROM OTHER COMBUSTIBLE OBJECTS.

LP3s 2.7A 11.88V
BAL 005: 39 00256 Once charging has commenced, the charger will display the following real-time information: battery type/cell count, charging current, battery voltage, charging time and charged capacity.

To view the voltage of each individual cell charging, press the + button.

Once the battery is fully charged the screen will read “FINISHED” and the charger will emit a chiming sound. Press the ■ button to stop charging. You may also press the ■ button at any time during the charging process to stop charging.

4.07 4.06 4.11V
0.00 0.00 0.00V

Lithium Battery Program [LiPO/LiHV/LiFe/Lilon cont.]

Lithium Fast Charge Mode:

Charging in Fast Charge Mode allows for a shorter charge time and will result in a slightly reduced charging capacity. To achieve maximum charge capacity, we recommend you use the Lithium Balance Charge Mode. If a fast charge is necessary, select the fast charge mode and follow the same charging instructions as for the Lithium Charge Mode or Lithium Balance Charge Mode.



Warning

BEFORE YOU BEGIN CHARGING YOUR BATTERY, MAKE SURE YOU HAVE READ AND UNDERSTAND ALL OF THE WARNINGS AND SAFETY INFORMATION CONTAINED ON PAGES 2 - 7.



Note

IN THE CHARGE MODE, LITHIUM BATTERIES CAN BE CHARGED WITHOUT THE USE OF A BALANCE ADAPTOR. A BALANCE ADAPTOR CAN BE USED, BUT IT IS NOT REQUIRED. BALANCE CHARGE MODE IS RECOMMENDED FOR ANY BATTERY WITH A BALANCE LEAD.

See page 12 for the appropriate charging connections setup for this operation.

4.07 4.06 4.11V
0.00 0.00 0.00V

First, select the correct battery type by following the instructions above. Once you have set the correct battery type, press the ► button once to enter the charge mode and battery settings screen, use the INC. – or DEC + to select “FAST CHG” mode. Press the ► button again and the amp rate value will begin flashing. Use the + or – buttons to adjust the value to the desired rate. Follow the instructions provided with your battery when setting the charge amperage rate.

Press the ► button again and the voltage value will begin flashing. Use the + or – buttons to adjust the value to the desired rate. The voltage and cell count should match the values listed on the battery label.

R: 3SE R: S: 3SER
CANCEL(STOP)

R: 3SE R: S: 3SER
CONFIRM(ENTER)

You are now ready to begin charging. Press and hold the ENTER/Start ► button until you see “BATTERY CHECK” followed by the “CONFIRM (ENTER) / CANCEL(STOP)” screen. This screen displays the number of cells you set up as “R” and the number of cells detected by the processor as “S”. If both numbers are identical, you may press and hold the ENTER/Start ► button to confirm and begin charging. If these numbers do not match, press the BATT/PROG Stop ■ button to return to the previous screen and carefully check the number of cells of the battery pack before proceeding.

Lithium Battery Program [LiPO/LiHV/LiFe/Lilon cont.]



Caution

DURING CHARGING/DISCHARGING, THE BATTERY SHOULD BE PLACED INSIDE A FIRE PROOF/RETARDANT BAG AND ON A FIRE PROOF SURFACE AWAY FROM OTHER COMBUSTIBLE OBJECTS.

LP3s 2.7A 11.88V
FAS 005:39 00256

Once charging has commenced, the charger will display the following real-time information: battery type/cell count, charging current, battery voltage, charging time and charged capacity.

4.07 4.06 4.11V
0.00 0.00 0.00V

If you are using a balance adaptor during charging, you may press the + button to view the voltage of each individual cell. You can also view a variety of other information as detailed on page 13.

Once the battery is fully charged the screen will read "FINISHED" and the charger will emit a chiming sound. Press the ■ button to stop charging. You may also press the ■ button at any time during the charging process to stop charging.

Lithium Storage Mode:

This function is for charging/discharging batteries that will not be used immediately. The program is designed for charging/discharging batteries up-to or down-to safe storage levels. The program will automatically begin to discharge if the current state of the battery exceeds the voltage level for storage.



Warning

BEFORE YOU BEGIN CHARGING YOUR BATTERY, MAKE SURE YOU HAVE READ AND UNDERSTAND ALL OF THE WARNINGS AND SAFETY INFORMATION CONTAINED ON PAGES 2 - 7.



Note

IN STORAGE MODE, LITHIUM BATTERIES CAN BE CHARGED WITHOUT THE USE OF A BALANCE ADAPTOR. A BALANCE ADAPTOR CAN BE USED, BUT IT IS NOT REQUIRED. BALANCE CHARGE MODE IS RECOMMENDED FOR ANY BATTERY WITH A BALANCE LEAD.

See page 12 for the appropriate charging connections setup for this operation.

LiPo STORAGE
2.7A 11.1V (3S)

First, select the correct battery type by following the instructions above. Once you have set the correct battery type, press the ► button once to enter the charge mode and battery settings screen, use the INC. – or DEC + to select "STORAGE" mode. Press the ► button again and the amp rate value will begin flashing. Use the + or – buttons to adjust the value to the desired rate. Follow the instructions provided with your battery when setting the charge amperage rate.

Lithium Battery Program [LiPO/LiHV/LiFe/Lilon cont.]

Press the ► button again and the voltage value will begin flashing. Use the + or – buttons to adjust the value to the desired rate. The voltage and cell count should match the values listed on the battery label.

R: 3SE R: S: 3SER
CANCEL(STOP)

You are now ready to begin charging. Press and hold the ENTER/Start ► button until you see “BATTERY CHECK”

R: 3SE R: S: 3SER
CONFIRM(ENTER)

followed by the “CONFIRM (ENTER) / CANCEL(STOP)” screen. This screen displays the number of cells you set up as “R” and the number of cells detected by the processor as “S”. If both numbers are identical, you may press and hold the ENTER/Start ► button to confirm and begin charging. If these numbers do not match, press the BATT/PROG Stop ■ button to return to the previous screen and carefully check the number of cells of the battery pack before proceeding.



Caution

DURING CHARGING/DISCHARGING, THE BATTERY SHOULD BE PLACED INSIDE A FIRE PROOF/RETARDANT BAG AND ON A FIRE PROOF SURFACE AWAY FROM OTHER COMBUSTIBLE OBJECTS.

LP3e 2.7A 11.89V
STD 005: 39 00256

Once charging has commenced, the charger will display the following real-time information: battery type/cell count, charging current, battery voltage, charging time and charged capacity.

4.07 4.06 4.11V
0.00 0.00 0.00V

If you are using a balance adaptor during charging, you may press the + button to view the voltage of each individual cell.

Once the battery has reached storage level the screen will read “STORAGE FINISHED” and the charger will emit a chiming sound. Press the ■ button to stop charging. You may also press the ■ button at any time during the charging process to stop charging.

Lithium Discharge Mode:

If you plan to discharge your battery to reach safe storage levels, we strongly recommend that you use Storage Mode. In very few instances should discharging become necessary with LiPo batteries. One such instance may include preparing a battery for disposal, in which case, the battery should not be completely discharged. Be sure to follow the discharging instructions provided by the battery manufacturer. **Over-discharging a battery can severely damage the battery and may cause a fire or explosion.**

Lithium Battery Program [LiPo/LiHV/LiFe/Lilon cont.]



Warning

DISCHARGING LITHIUM CHEMISTRY BATTERIES CAN CAUSE PERMANENT DAMAGE TO THE BATTERY AND IT IS NOT RECOMMENDED FOR ANYTHING OTHER THAN THE DISPOSAL OF THE BATTERY. IF YOU CHOOSE TO DISCHARGE YOUR LITHIUM BATTERIES, MAKE SURE TO PAY CLOSE ATTENTION TO THE MINIMUM VOLTAGE SETTING. IF YOU WANT TO STORE YOUR BATTERY FOR A LONG PERIOD OF TIME, YOU SHOULD UTILIZE THE STORAGE MODE CHARGE PROGRAM AS THIS IS THE SAFEST METHOD OF STORING YOUR LITHIUM CHEMISTRY BATTERIES.



Note

IN DISCHARGE MODE, LITHIUM BATTERIES CAN BE DISCHARGED WITH OR WITHOUT THE USE OF A BALANCE ADAPTOR. THE USE OF A BALANCE ADAPTOR IS RECOMMENDED FOR DISCHARGING ANY BATTERY THAT HAS A BALANCE LEAD.

See page 12 for the appropriate charging connections setup for this operation.

LiPo DISCHARGE
2.7A 11.1V (3S)

First, select the correct battery type by following the instructions above. Once you have set the correct battery type, press the ► button once to enter the charge mode and battery settings screen, use the INC. – or DEC + to select “DISCHARGE” mode. Press the ► button again and the amp rate value will begin flashing. Use the + or – buttons to adjust the value to the desired rate. Follow the instructions provided with your battery when setting the charge amperage rate.

Press the ► button again and the voltage value will begin flashing. Use the + or – buttons to adjust the value to the desired rate. The voltage and cell count should match the values listed on the battery label.

R: 3SE R S: 3SER
CANCEL(STOP)

R: 3SE R S: 3SER
CONFIRM(ENTER)

You are now ready to begin charging. Press and hold the ENTER/Start ► button until you see “BATTERY CHECK”, followed by the “CONFIRM (ENTER) / CANCEL(STOP)” screen. This screen displays the number of cells you set up as “R” and the number of cells detected by the processor as “S”. If both numbers are identical, you may press and hold the ENTER/Start ► button to confirm and begin charging. If these numbers do not match, press the BATT/PROG Stop ■ button to return to the previous screen and carefully check the number of cells of the battery pack before proceeding.

Lithium Battery Program [LiPO/LiHV/LiFe/Lilon cont.]



Caution

DURING CHARGING/DISCHARGING, THE BATTERY SHOULD BE PLACED INSIDE A FIRE PROOF/RETARDANT BAG AND ON A FIRE PROOF SURFACE AWAY FROM OTHER COMBUSTIBLE OBJECTS.

LP3s 2.7A 11.88V
DCH 005:39 00256

Once charging has commenced, the charger will display the following real-time information: battery type/cell count, charging current, battery voltage, charging time and charged capacity.

4.07 4.06 4.11V
0.00 0.00 0.00V

If you are using a balance adaptor during charging, you may press the + button to view the voltage of each individual cell.

Once the battery has reached storage level the screen will read "FINISHED" and the charger will emit a chiming sound. Press the ■ button to stop charging. You may also press the ■ button at any time during the charging process to stop charging.

Additional Lithium Battery Process Information:

During the Lithium battery charging/discharging process, the X2 High Power can display a variety of information. Pressing the + button allows you to see the following:

4.07 4.06 4.11V
0.00 0.00 0.00V

Voltage of each cell.

Fuel = 90%
Cell = 4.10V

Charge capacity percentage and average cell voltage.

Pressing the — button will display this information.

End Voltage
12.6VC3S)

Final voltage setting

In Power Voltage
12.56V

Input voltage

Ext. Temp ----
Int. Temp 37°C

Internal/external temperature*

Temp Cut-off
50°C

Cut-off temperature

Ext. Temp ----
Int. Temp 37°C

Safety timer settings

Temp Cut-off
50°C

Capacity cut off settings

*Requires optional temperature sensor. (Part#: 44159)

NiCd/NiMH Battery Program

NiCd/NiMH:

This program is only suitable for charging/discharging NiCd/NiMH batteries. The X2 High Power offers the following NiCd/NiMH charge modes: Charge, Auto Charge, Discharge, Re-Peak and Cycle.

Selecting the Battery Type:

After powering on the X2 High Power, it will default to the LiPo Balance charge screen, press the **■** button to exit this menu to revert back to the "BATT/PROGRAM" SCREEN. Press the + or - key to select appropriate program for the battery type you wish to charge. For this example, we have chosen the "NiMH BATT" or "NiCd BATT" program. Now press the **▶** button to enter the desired program.

NiCd/NiMH Charge Mode:



BEFORE YOU BEGIN CHARGING YOUR BATTERY, MAKE SURE YOU HAVE READ AND UNDERSTAND ALL OF THE WARNINGS AND SAFETY

Warning INFORMATION CONTAINED ON PAGES 2 - 7.

NiMH CHARGE CURRENT 1.3A After selecting the correct battery type, if the screen does not read "CHARGE", use the + or **—** buttons to change it to the "CHARGE" mode.

Press the **▶** button and the amp rate value will begin flashing. Use the + or **—** buttons to adjust the value to the desired rate. Follow the instructions provided with your battery when setting the amperage rate.

Press and hold the **▶** button to begin charging.

Once charging has commenced, the charger will display the following real-time information: battery type, charging current, battery voltage, charging time and charged capacity. Once the battery is fully charged, the screen will read "END: FINISH" and the charger will emit a chiming sound. You can press the **■** button at any time during the charging process to stop charging.

NICD AND NIMH BATTERY TEMPERATURES WILL INCREASE AS THE VOLTAGE OF THE PACK NEARS A FULL CHARGE. THIS IS CONSIDERED NORMAL.

NiCd/NiMH Battery Program [cont.]

NiCd/NiMH Auto Charge Mode:

In this mode, the charger automatically detects the connected NiMH or NiCd battery and determines the proper full charge and cutoff thresholds. Setting the upper charge current limit for safe levels based on your battery specifications will ensure safe charging of your specific battery. If you are unsure of the maximum allowable charge rates, set the charger to a maximum of 1C (battery mAh/1000, i.e., 2500mAh = 2.5A).



BEFORE YOU BEGIN CHARGING YOUR BATTERY, MAKE SURE YOU HAVE READ AND UNDERSTAND ALL OF THE WARNINGS AND SAFETY

Warning INFORMATION CONTAINED ON PAGES 2 - 7.

NiMH Auto CHARGE
CURRENT 1.3A

After selecting the correct battery type, use the + or — buttons to change the charge mode to the “Auto CHARGE” setting.

Press the ► button and the amp rate value will begin flashing. Use the + or — buttons to adjust the value to the desired rate. Follow the instructions provided with your battery when setting the upper charge amperage rate.

Press and hold the ► button to begin charging.

NiMH 1.3A 5.42V
AUT 002:22 00106

Once charging has commenced, the charger will display the following real-time information: battery type, charging current, battery voltage, charging time and charged capacity.

Once the battery is fully charged, the screen will read “END: FINISHED” and the charger will emit a chiming sound. You can press the ■ button at any time during the charging process to stop charging.

NiCd/NiMH Discharge Mode:



BEFORE YOU BEGIN DISCHARGING YOUR BATTERY, MAKE SURE YOU HAVE READ AND UNDERSTAND ALL OF THE WARNINGS AND SAFETY

Warning INFORMATION CONTAINED ON PAGES 2 - 7.

NiMH DISCHARGE
1.3A CUT: 9.8V

After selecting the correct battery type, use the + or — buttons to select to the “DISCHARGE” mode. Press the ► button and the amp rate value will begin flashing. Use the + or — buttons to adjust the value to the desired discharge rate. Press the ► button again and the voltage cutoff will begin to flash. Use the + or — buttons to adjust the value to the desired rate.

NiCd/NiMH Battery Program [cont.]

Follow the instructions provided with your battery when setting the voltage cutoff. The X2 High Power will stop discharging when the battery has reached the preset voltage cutoff.

 Press and hold the ► button to begin discharging. Once discharging has commenced, the charger will display the following real-time information: battery type, discharging current, battery voltage, discharging time and discharged capacity.

 When discharging is complete, the screen will read “END: CUTOFF-VOL” and the charger will emit a chiming sound. The charger will display the elapsed time, end voltage and number of mAh discharged.

You can press the ■ button at any time during the charging process to stop the discharge process.

NiCd/NiMH Re-Peak Mode:



BEFORE YOU BEGIN CHARGING YOUR BATTERY, MAKE SURE YOU HAVE READ AND UNDERSTAND ALL OF THE WARNINGS AND SAFETY

Warning INFORMATION CONTAINED ON PAGES 2 - 7.

Applicable to NiMH and NiCd batteries only, in re-peak mode, the charger can peak charge the battery once, twice, or three times in a row automatically. This process is good for confirming the battery is fully charged and for verifying how well the battery can accept a fast charge. A five-minute cool-down delay occurs after each re-peak charge.



Note

IN RE-PEAK MODE, THE X2 HIGH POWER USES THE CHARGE AMPERAGE AND VOLTAGE SETTINGS ENTERED IN CHARGE MODE (SEE PAGE 25).

 After selecting the correct battery type, use the + or — buttons to select to the “RE-PEAK” mode. Press the ► button and Re-peak cycle number 1 begins to flash on the screen. Use the + or — buttons, the dial will allow you to scroll through and set up to 3 total cycles.

Press the ► button to begin the re-peak process.

NiCd/NiMH Battery Program [cont.]

NiMH 1.3A 10.42V
FPC 004: 04 00686 Once the Re-Peak process has begun, the charger will display the following real-time information: battery type, charging current, battery voltage, elapsed time and charged capacity.

Once the Re-Peak process has completed, the screen will read “END: RE-PEAK” and the charger will emit a chiming sound. The X2 High Power will display the charge/discharge capacity for each cycle. Using the + and - buttons, you can scroll through this data for each cycle.

NiCd/NiMH Cycle Mode:

The X2 High Power makes cycling of NiCd/NiMH batteries easy. The process of discharging and recharging (cycling) can be achieved automatically with one simple step and will improve the performance of NiCd/NiMH batteries. We strongly recommend cycling any battery that has been discharged and stored for a period of time. This will increase battery life and improve performance.



Warning

BEFORE YOU BEGIN CHARGING YOUR BATTERY, MAKE SURE YOU HAVE READ AND UNDERSTAND ALL OF THE WARNINGS AND SAFETY INFORMATION CONTAINED ON PAGES 2 - 7.



Note

FOR CYCLING, THE X2 HIGH POWER USES THE CHARGE/DISCHARGE AMPERAGE AND VOLTAGE SETTINGS ENTERED IN THE CHARGE AND DISCHARGE MODES (SEE PAGE 16).

NiMH CYCLE
DCHG > CHG 2 After selecting the correct battery type, use the + or — buttons to select to the “CYCLE” mode. The Cycle Mode gives you two cycling options: “DCHG>CHG” or “CHG>DCHG”. The “DCHG>CHG” option will first discharge the battery and then charge the battery.

NiMH CYCLE
CHG > DCHG 5 The “CHG>DCHG” option will first charge the battery and then discharge the battery. If this screen does not currently show the cycling option you desire, press the ► button once and this setting will begin flashing. Use the + or — buttons to change this setting.

Pressing the ► button again will cause the number of cycle options to begin flashing. Use the + or — buttons to change this to the number of cycles you want the X2 High Power to run. The X2 High Power can cycle the battery a maximum of 5 times consecutively.

Press and hold the ► button and cycling will begin.

NiCd/NiMH Battery Program [cont.]

NiMH 0.5A 9.6V Once cycling has commenced, the charger will display the following real-time information: battery type, charging/discharging current, battery voltage, charging time and charged capacity. You will also see "D>C" or "C>D". This will indicate which cycling order you have chosen. Either "D" or "C" will be flashing. This flashing indicates which part of the cycle is currently being executed.

Once the cycling process is complete, the screen will read "END: CYCLE" and the charger will emit a chiming sound. The X2 High Power will display the charge/discharge capacity for each cycle. Using the + and — buttons, you can scroll through this data for each cycle.

Additional NiCd/NiMH Process Information:

During the NiMH/NiCd battery charging/discharging process the X2 High Power can display a variety of information, using the + or — buttons you can also view the following information:

NiMH Sensitivity D.Peak 4mV/CELL	Delta Peak sensitivity setting	In Power Voltage 12.58V	Input Voltage
Ext. Temp ---- Int. Temp 37°C	External*/internal temperatures	Temp Out-off 50°C	Temperature cut-off
Safety ON	Time 200min	Capacity Out-Off ON	5000mAh Capacity cut-off setting

*Requires optional temperature sensor. (Part#: 44159)

Pb Lead-Acid Battery Program

Pb (Lead-Acid):

BATT./PROGRAM
Pb BATT This program is only suitable for charging Pb (lead-acid) batteries with nominal voltages of 2 to 20V. A Pb (lead-acid) battery is significantly different from NiCd/NiMH batteries. Pb batteries can only deliver current lower in comparison to their capacity. The same restriction applies to the charging process. Consequently, the optimum charge current can only be 1/10th of the capacity. A Pb battery cannot be used for fast charging. Please follow the instructions provided by the battery manufacturer.

The X2 High Power offers the following Pb charge modes: Charge and Discharge.

Pb Lead-Acid Battery Program [cont.]

Pb Charge Mode:



BEFORE YOU BEGIN CHARGING YOUR BATTERY, MAKE SURE YOU HAVE READ AND UNDERSTAND ALL OF THE WARNINGS AND SAFETY

Warning INFORMATION CONTAINED ON PAGES 2 - 7.

After selecting the correct battery type, use the + or — buttons to change it to the “CHARGE” mode.

Press the ► button and the amp rate value will begin flashing. Use the + or — buttons to adjust the value to the desired charge rate. The amp rate should be set to 1/10th of capacity. For example, if you are charging a 7Ah battery the charge rate should be set to 0.7A. Follow the instructions provided with your battery when setting the amp rate.

Pb Charge
1.5A 12.0UCBP>

Press the ► button again and the voltage rate value will begin flashing. Use the + or — buttons to set the voltage and number of cells.

Press and hold the ► button and charging will begin.

P-6 1.5A 13.58V
CHG 002:22 00106

Once charging has commenced, the charger will display the following real-time information: battery type, charging current, battery voltage, charging time and charged capacity.

When charging is complete, the screen will read “FINISHED” and the charger will emit a chiming sound.

Pb Discharge Mode:



BEFORE YOU BEGIN CHARGING YOUR BATTERY, MAKE SURE YOU HAVE READ AND UNDERSTAND ALL OF THE WARNINGS AND SAFETY

Warning INFORMATION CONTAINED ON PAGES 2 - 7.

After selecting the correct battery type, use the + or — buttons to change it to the “DISCHARGE” mode.

Press the ► button and the amp rate value will begin flashing. Use the + or — buttons to adjust the value to the desired charge rate. The amp rate should be set to 1/10th of capacity. For example, if you are discharging a 7Ah battery the discharge rate should be set to 0.7A. Follow the instructions provided with your battery when setting the amp rate.

Pb Lead-Acid Battery Program [cont.]

Pb Discharge
1.5A 12.00C6P> Press the ► button again and the voltage rate value will begin flashing. Use the + or — buttons to set the voltage and number of cells.

Press and hold the ► button and discharging will begin.

P-6 1.0A 13.58V
DCH 005: 10 0096H Once charging has commenced, the charger will display the following real-time information: battery type, charging current, battery voltage, charging time and charged capacity.

When charging is complete, the screen will read “FINISHED” and the charger will emit a chiming sound.

Additional Pb Process Information:

During the Pb battery charging/discharging process the X2 High Power can display a variety of information. Using the + or - buttons you can also view the following information:

Capacity Cut-Off
ON 5000mAh

Capacity cut-off setting

Safety Time
ON 200min

Safety timer setting

Temp Cut-off
50°C

Temperature cut-off

Ext. Temp ----
Int. Temp 37°C

External*/internal temperatures

In Power Voltage
12.58V

Input voltage

*Requires optional temperature sensor. (Part#: 44159)

Battery Meter

Battery Meter:

You can use the battery meter function to check your battery's total voltage, the highest voltage, the lowest voltage, and the voltage of each cell. Simply connect the battery to the charger via the main battery lead to the battery socket and the balance wires to the balance socket as shown below.

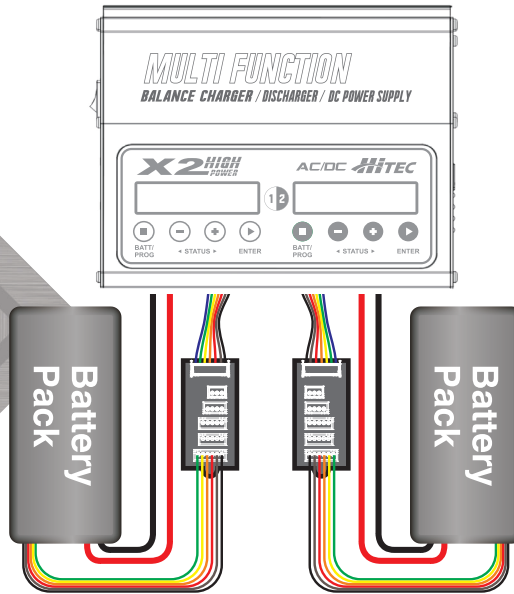

BATT/PROGRAM
BATT METER From the BATT/PROGRAM menu use the + or — buttons to scroll to the BATT METER program, press the ENTER/Start ► button to enter the battery meter program.

4.20 4.19 4.19V
4.18 4.18 4.19V The first screen indicates each cell's voltage.

MAIN 25.13V
H: 200 V L: 182V Press the + or — buttons to view the packs total voltage and the cell with the highest and lowest voltage.

Battery Resistance Measurement

Battery Resistance Measurement:

The X2 High Power has the ability to check your battery's total internal resistance, highest total resistance, lowest total resistance and the resistance of each cell. Simply connect the battery to the charger via the main battery lead to the battery socket and the balance wires to the balance socket as shown below.

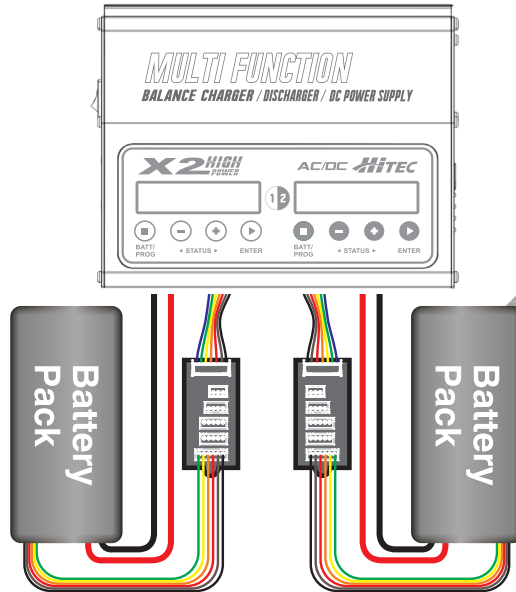

BATT/PROGRAM
BATT RESISTANCE From the BATT/PROGRAM menu use the + or — buttons to scroll to the BATT RESISTANCE program, press the ENTER/Start ► button to enter the battery resistance meter program.

012 005 005 mΩ
006 mΩ The first screen indicates each cell's internal resistance.

TOTAL: mΩ
H: 12mΩ L: 5mΩ Press the + or — buttons to view the packs total voltage and the cell with the highest and lowest internal resistance.

DC Power Output Connection

The Hitec X2 High Power charger has a unique function that enables you to connect an additional DC powered device to it, utilizing the DC power output port while the charger is being powered by AC power. DC port output power can be adjusted between 10-150 Watts (see page 13).

See Example Below:

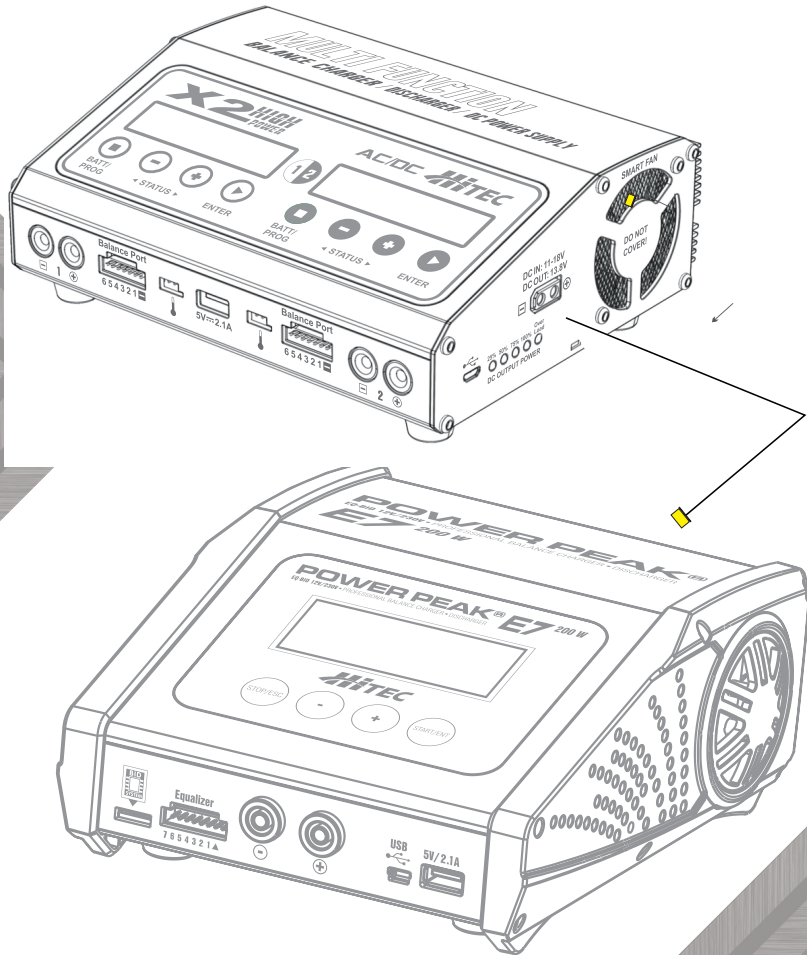

Memory Preset - Data Save/Load [cont.]

Memory Preset - Data Save/Load:

The Save Data and Load Data programs make it easy to store and load charge and discharge profiles for up to 10 batteries per channel. Data can be saved for each battery type and each charge mode available with the X2 High Power. This allows you to recall data for each battery when charging or discharging without having to set up the program over again. You can also edit settings for each saved battery.

Save Data:

**[BATT MEMORY 1]
ENTER SET ->** From the BATT/PROGRAM menu use the + or — buttons to scroll to the BATT MEMORY program and press the ENTER/Start ► button to enter the battery memory program. In the corner of the screen, you will see the number 1 flashing, use the + or — buttons to scroll through the memories. When you are ready to select a memory to program, press the ► button again to enter the memory setup menu.

**BATT TYPE
LiPo** Press the ► button again and the battery type will begin to flash. Use the + or — buttons to select the battery type (LiPo, LiFe, Lilon, LiHV, NiMH, NiCd or Pb, then press the ► button to confirm your selection.

Now you will use + or — buttons to scroll through the battery parameters, using the + you will make adjustments in the following order, using the — button will reverse this order.

**BATT VOLTS
7.4V (2S)** **Voltage and Number of Cells:** Press the ► button and the number of cells will begin to flash. Use the + or — buttons to change the cell count then press the ► button to confirm your selection.

**CHARGE CURRENT
4.9A** **Charge Current:** Press the ► button and the charge current value will begin to flash. Use the + or — buttons to change the charge current then press the ► button to confirm your selection.

**DSCH CURRENT
2.0A** **Discharge Current:** Press the ► button and the discharge current value will begin to flash. Use the + or — buttons to change the discharge current then press the ► button to confirm your selection.

Memory Preset - Data Save/Load [cont.]

DSCH VOLTAGE
3.0V/CELL

Per Cell Discharge Voltage: Press the ► button and the per cell discharge voltage value will begin to flash. Use the + or — buttons to change the per cell discharge voltage, then press the ► button to confirm your selection.



MAKE SURE TO FOLLOW YOUR BATTERY MANUFACTURER'S RECOMMENDATIONS REGARDING DISCHARGING. FAILURE TO DO SO

Warning MAY DESTROY THE BATTERY OR RENDER IT UNSAFE FOR USE.

TVC = YOU R RISK
4.20V

Terminal Voltage: Press the ► button and the terminal voltage value will begin to flash. Use the + or — buttons to change the terminal voltage, and then press the ► button to confirm your selection.



CHANGING THE TERMINAL VOLTAGE IS ONLY INTENDED FOR EXPERT USERS, ANY CHANGES TO DEFAULT SETTINGS ARE COMPLETELY AT YOUR

Warning OWN RISK.

SAVE PROGRAM
ENTER

Save Program: Press the ► button to save the program.

SAVE PROGRAM
SAVE...

SAVE..... will appear momentarily while the program is written to the memory.

[BATT MEMORY 1]
LiPo 7.4V (2S)

Once saved, the screen indicates the memory number, battery type, cell count, charge current and discharge current.

[BATT MEMORY 1]
C: 4.9 D: 2.2A

Recall Memory:

ENTER CHARGER
LOAD...

From the BATT/PROGRAM menu use the + or — buttons to scroll to the BATT MEMORY program and press ► button to enter the battery memory program. Use the + or — buttons to scroll through the memories. When you have found the memory you would like to use, press the ► button again to recall the memory.





LiPo BALANCE CHG
4.9A 7.4V (2S)

Use the + or — buttons to scroll the available processes (charge, discharge, balance charge etc.). Select the process you would like to execute for the battery, then press and hold the ► button for 3 seconds to begin the selected process.

Advanced System Set Up

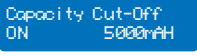
The system will be set to its default parameters when powered on for the first time. The screen displays the following information in sequence and the user can change any given value on each screen.

To change a parameter value in the program, press START/ENTER to make that value blink. Next, change the value by pressing INC or DEC. The value will be stored by pressing START/ENTER once.

ITEM	SELECTION	DESCRIPTION
	ON / OFF (1-720 Min)	When you start a charge process, the integral safety timer automatically starts running at the same time. This is programmed to prevent overcharge of the battery if it proves to be faulty, or if the termination circuit cannot detect the battery is full. The value for the safety timer should be generous enough to allow a full charge of the battery.
	ON / OFF (100-50,000 mAh)	This program sets the maximum charge capacity that will be supplied to the battery during charge. If the delta peak voltage is not detected or the safety timer is expired for any reason, this feature will automatically stop the process at the selected capacity value.
	ON / OFF 20°C / 68°F - 80°C / 176°F	The battery's internal chemical reaction will cause the temperature of the battery to rise. If the temperature limit is reached, the process will be terminated.
	Celsius Fahrenheit	You can choose the temperature displayed by Celsius or Fahrenheit as you like.
	1-60 Min	A rest time allows the battery to cool down between charging/discharging cycle.

Advanced System Set Up [cont.]

<p>NiMH Sensitivity D.Peak Default</p>	<p>Default: 4mV/Cell 5-15mV/Cell</p>	<p>This program is for NiMH/NiCd batteries only. When the charger detects the delta peak value reaches the value you set, the charger will say the battery is fully charged.</p>
<p>NiCd Sensitivity D.Peak Default</p>		
<p>Key Beep ON Buzzer ON</p>	<p>OFF/ON</p>	<p>The beep sounds every time you touch the buttons to confirm your action. The beep or melody sounds at various times during operation to alert you to different mode changes.</p>
<p>Input Power Low Cut-Off 11.00</p>	<p>10.0-11.0V</p>	<p>The program monitors the input voltage of the battery. If the voltage drops below the value you set, the operation forcibly terminates to protect the input battery.</p>
<p>Synchronization OFF</p>	<p>Selection ON / OFF</p>	<p>This function allows you to synchronize both channels with each other to streamline programming of identical batteries on both channels.</p>
<p>Load Factor Set Enter</p>		<p>Press ENTER to load factory default setting.</p>
<p>Version HW: 1.0 0 FW: 1.10</p>		<p>It indicates the hardware and firmware version.</p>
<p>CH: 1 120W CH2: 120W DC POWER: LOW</p>		<p>This menu allows you to adjust the amount of power going to each channel and the amount of power distributed to the DC power output port when powering the charger off of AC power.</p>

Warning and Error Messages

In the case of an error, the screen will communicate the cause of the error and emit an audible sound.

REVERSE POLARITY

An incorrect polarity is detected.

CONNECTION BREAK

The battery has been interrupted.

CONNECT ERROR
CHECK MAIN PORT

The battery connection is incorrect.

BALANCE CONNECT
ERROR

The balance connect is incorrect.

DC IN TOO LOW

The input voltage is less than 11V.

DC IN TOO HIGH

The input voltage is higher than 18V.

CELL ERROR
LOW VOLTAGE

The Voltage of one cell in the battery pack is too low.

CELL ERROR
HIGH VOLTAGE

The voltage of one cell in the battery pack is too high.

CELL ERROR
VOLTAGE-INVALID

The voltage of one cell in the battery pack is invalid.

CELL NUMBER
INCORRECT

The cell number is wrong.

INT. TEMP. TOO HI

The internal temperature of the unit is too high.

EXT. TEMP. TOO HI

The external temperature of the battery is too high.

OVER CHARGE
CAPACITY LIMIT

The battery capacity is more than the maximum capacity set by the user.

OVER TIME LIMIT

The charging time is longer than the maximum charging time set by the user.

BATTERY WAS FULL

The battery voltage is higher than the maximum voltage set by the user when charging in balance mode.

Using the Charge Control Software [Charge Master]

The free “Charge Master 3.02” software gives you the unparalleled ability to operate the charger through your computer. You can monitor pack voltage, cell voltage, and other data during charging, view the charge data in real-time graphs, or control charging and firmware updates from the “Charge Master 3.02.”

In order to connect the charger to a computer and enjoy the benefits of the “Charge Master 3.02” program, you will need a USB cable which is not included in this package. The cable must have an “A” plug on one end and a “micro-B” plug on the other to connect to the charger directly. You can control, monitor, operate, and upgrade two channels with one computer. The “Charge Master 3.02” is available for download at www.hitecrd.com.

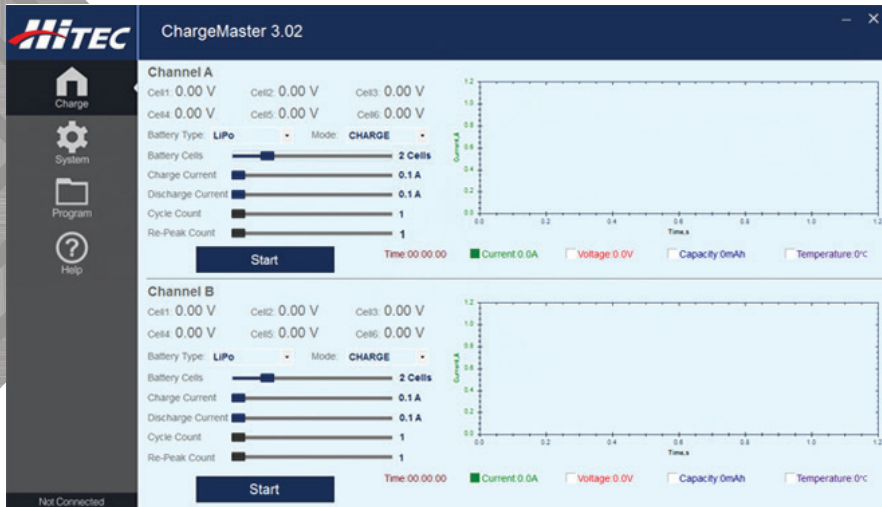

Commonly Used Terms

Commonly Used Terms:

A, mA: Unit of measurement relating to a charge or discharge current. $1000 \text{ mA} = 1 \text{ A}$ (A = Ampere, mA = Milliampere).

Ah, mAh: Unit of measurement for the capacity of a battery (Amperes x Time Unit; h = hour). If a pack is charged for one hour at a current of 2A, it has been fed 2Ah of energy. It receives the same quantity of charge (2Ah) if it is charged for 4 hours at 0.5A, or 15 minutes ($=1/4$ hour) at 8A.

'C' - Rating: Capacity is also referred to as the 'C' rating. Some battery suppliers recommend charge and discharge currents based on the battery 'C' rating. A battery's '1C' current is the same number as the battery's rated capacity number, but noted in mA or amps. A 600mAh battery has a 1C current value of 600mA, and a 3C current value of ($3 \times 600\text{mA}$) 1800mA or 1.8A. The 1C current value for a 3200mAh battery would be 3200mA (3.2A).

Final Charge Voltage: The voltage at which the battery's charge limit (capacity limit) is reached after which the charge process switches from a high current to a low maintenance rate (trickle charge). From this point on, any further high current charging would cause overheating and eventual terminal damage to the pack.

Final Discharge Voltage: The voltage at which the battery's discharge limit is reached. The chemical composition of the batteries determines the level of this voltage. Below this voltage, the battery enters deep discharge zone. Individual cells within the pack may become reverse polarized under these conditions, resulting in permanent damage.

Nominal Voltage (V): The nominal voltage of the battery pack can be determined as follows:

- **NiCd or NiMH:** Multiply the total number of cells in the pack by 1.2. An 8-cell pack will have a nominal voltage of 9.6 volts (8×1.2).

- **LiPo:** Multiply the total number of cells in the pack by 3.7. A 3-cell LiPo wired in series will have a nominal voltage of 11.1 volts (3×3.7).

4-cell LiHV wired in a series will have a nominal voltage of 14.8 volts. (4×3.7).

Commonly Used Terms [cont.]

- **Lilon:** Multiply the total number of cells in the pack by 3.6. A 2-cell Lilon wired in a series will have a nominal voltage of 7.2 volts (2 x 3.6).
- **LiFe:** Multiply the total number of cells in the pack by 3.3. A 4-cell LiFe wired in a series will have a nominal voltage of 13.2 volts. (4 x 3.3).
- **LiHV:** Multiply the total number of cells in the pack by 3.7. A 4-cell LiHV wired in a series will have a nominal voltage of 14.8 volts. (4 x 3.7).



Note

If the nominal voltage of the battery is not printed on the battery's label, consult your battery manufacturer or supplier. Do not attempt to guess the rated voltage of the battery.

Conformity Declarations

Hitec's X2 High Power Plus satisfies all relevant and mandatory CE directives and complies with FCC Part 15 Subpart B: 2010. For EC directives: The product has been tested to meet the following technical standards:

Test Standards	Title	Result
EN55014-1:2006+ A1:2009+A2:2011	Electromagnetic compatibility - Requirements for household appliances, electric tools and similar apparatus - Part 1: Emission	Conform
EN55014-2: 2015	Electromagnetic compatibility - Requirements for household appliances, electric tools and similar apparatus - Part 2: Immunity - Product family standard	Conform
EN 61000-3-2:2014	Electromagnetic compatibility (EMC) - Part 3-2: Limits - Limits for harmonic current emissions (equipment input current <= 16 A per phase)	Conform
EN 61000-3-3:2013	Electromagnetic compatibility (EMC) - Part 3-3: Limits - Limitation of voltage changes, voltage fluctuations and flicker in public lowvoltage supply systems, for equipment with rated current <= 16 A per phase and not subject to conditional connection	Conform
EN 60335-1: 2012 +A11: 2014	Household and similar electrical appliances - Safety - Part 1: General requirements	Conform
EN 60335-2-29: 2004+A2: 2010	Household and similar electrical appliances - Safety - Part 2: Particular requirements for battery chargers	Conform
EN 62233: 2008	Measurement methods for electromagnetic fields of household appliances and similar apparatus with regard to human exposure	Conform

Disposal and Prop 65 Warning



This symbol indicates that when this type of electronic device reaches the end of its service life, it cannot be disposed of with normal household waste and must be recycled. To find a recycling center near you, refer to the internet or your local phone directory for electronic waste recycling centers.

STATE OF CALIFORNIA PROPOSITION 65 WARNING:

This product contains chemicals known to the State of California to cause cancer. Use caution when handling this product and avoid exposure to any electronic components or internal assemblies.

Warranty and Service

LIABILITY EXCLUSION:

This charger is designed and approved exclusively for use with the types of batteries stated in this Instruction Manual. Hitec RCD, USA accepts no liability of any kind if the charger is used for any purpose other than that stated. We are unable to ensure that you follow the instructions supplied with the charger, and we have no control over the methods you employ for using, operating and maintaining the device. For this reason, we are obliged to deny all liability for loss, damage or costs which are incurred due to any misuse or operation of our products. Unless otherwise prescribed by law, our obligation to pay compensation, regardless of the legal argument employed, is limited to the invoice value of Hitec RCD, USA products which were immediately and directly involved in the event in which the damage occurred.

ONE YEAR LIMITED WARRANTY:

For a period of one year from the date of purchase, HITEC RCD USA, INC. shall REPAIR OR REPLACE, at our option, defective equipment covered by this warranty, otherwise the purchaser and/or consumer is responsible for any charges for the repair or replacement of the charger. This warranty does not cover cosmetic damages and damages due to acts of God, accident, misuse, abuse, negligence, improper installation, or damages caused by alterations by unauthorized persons or entities. This warranty only applies to the original purchaser of this product and for products purchased and used in the United States of America, Canada and Mexico. Plastic cases are not covered by this warranty.

Warranty and Service [cont.]

THIS WARRANTY IS IN LIEU OF ANY AND ALL OTHER WARRANTIES, WHETHER FOR MERCHANTABILITY OR FITNESS FOR A PARTICULAR PURPOSE AND WHETHER EXPRESS OR IMPLIED. REPAIR OR REPLACEMENT AS PROVIDED UNDER THIS WARRANTY IS THE EXCLUSIVE REMEDY. HITEC RCD, INC. SHALL NOT BE LIABLE FOR ANY INCIDENTAL OR CONSEQUENTIAL DAMAGES FOR BREACH OF ANY EXPRESS OR IMPLIED WARRANTY RELATING TO THIS PRODUCT. EXCEPT TO THE EXTENT PROHIBITED BY APPLICABLE LAW. ANY IMPLIED WARRANTY OF MERCHANTABILITY OR FITNESS FOR A PARTICULAR PURPOSE ON THIS PRODUCT IS LIMITED IN DURATION TO THE DURATION OF THIS WARRANTY. REPAIR AND SERVICE.

To have your Hitec charger serviced:

1. Visit the Hitec website at www.hitecrcd.com and download the service request form (under Support section).
2. Fill out the service request form completely and include a copy of your original receipt showing the purchase date.
3. Package your product in its original packaging or use a suspension-type packaging (foam peanuts or crumpled newspaper). Hitec RCD shall not be responsible for goods damaged in transit.
4. Ship prepaid (COD or postage-due returns will not be accepted) via a traceable common courier (UPS, insured parcel post, FedEx, etc.) to:

Hitec RCD USA, Inc., Customer Service Center, 12115 Paine St., Poway CA 92064



W: www.hitecrd.com | E: service@hitecrd.com | P: 858.748.6948