



AC/DC

3.2" COLOR TOUCH SCREEN

AC/DC INPUT, PROFESSIONAL  
BALANCE CHARGER, DISCHARGER  
**multi charger**

# X1 TOUCH

## INSTRUCTION MANUAL



**Li-Po**  
1-6 cell

**Li-Fe**  
1-6 cell

**Li-ION**  
1-6 cell

**Ni-CD**  
1-15 cell

**Ni-MH**  
1-15 cell

**PB**  
2-20 V

**Introduction** ..... 3  
 Parts Layout ..... 4  
**Specifications and Charger Layout** ..... 5  
**Features** ..... 6  
**Warnings and Safety Notes** ..... 9  
**Power Supply Connections** ..... 12  
**Programing Interface** ..... 13  
**User Interface** ..... 14  
 Input Operation ..... 14  
**Initial Systems Setup** ..... 14  
 Settings Menu ..... 14  
 System Settings ..... 14  
**Safety Protection** ..... 15  
**Charger Parameters** ..... 16  
**Charger Operations** ..... 17  
 1. Battery Settings ..... 17  
 2. Charging Program ..... 19  
 3. Program Start ..... 20  
 4. Program Stop ..... 21  
 5. Program Complete ..... 21  
 Information Displayed During Operation ..... 22  
 1. Charging Status Monitor ..... 22  
 2. Graph ..... 22  
 3. Balance Status ..... 22  
 Using the Charge Master Charge Control Software ..... 23  
 Volt Meter ..... 23  
 Memory Presets - Data Store/Load ..... 24  
 1. Storing Presets ..... 24  
 2. Recalling Data ..... 24  
 Error Messages ..... 24  
**Warranty and Service** ..... 26

Please read this entire operating manual before using the X1 Touch Charger. If you are unsure of its proper operation after reading the manual, please seek advice from an experienced hobbyist or someone familiar with proper battery charging procedures.

**WARNING: THE CHARGING AND DISCHARGING OF RC HOBBY BATTERIES CAN BE DANGEROUS. FAILURE TO FOLLOW THESE EXPLICIT WARNINGS CAN RESULT IN PROPERTY DAMAGE AND/OR LOSS OF LIFE.**

- **NEVER EVER LEAVE YOUR CHARGER UNATTENDED WHILE IN OPERATION.**
- **NEVER CHARGE ON OR AROUND COMBUSTIBLE MATERIALS.**
- **NEVER CHARGE A DAMAGED BATTERY PACK.**
- **LOW COST, NO-NAME BATTERY PACKS POSE THE MOST DANGER. WE RECOMMEND YOU ONLY USE BATTERY PACKS THAT ARE SOLD AND WARRANTIED BY A REPUTABLE COMPANY.**
- **IT IS HIGHLY RECOMMENDED THAT YOU UTILIZE A SAFETY DEVICE SUCH AS A STEEL CASE OR LIPO SACK™ WHILE CHARGING LITHIUM CHEMISTRY BATTERIES.**
- **IT IS HIGHLY RECOMMENDED THAT YOU KEEP AN OPERABLE “CLASS A” FIRE EXTINGUISHER IN THE CHARGING AREA.**

**FAILURE TO FOLLOW THESE WARNINGS CAN BE CONSIDERED NEGLIGENCE BY THE OPERATOR AND MAY NEGATE ANY CLAIMS FOR DAMAGES INCURRED.**

Hitec RCD USA will not be held responsible for any damages or injuries that may occur by persons who fail to follow these warnings or who fail to properly follow the instructions in this manual.

Congratulations on your choice of the Hitec X1 Touch digital, intelligent touch screen interface charger from Hitec RCD USA. The Hitec X1 Touch is a high-performance, microprocessor controlled charge/discharge station with battery management capabilities that are suitable for use with most popular battery types. The X1 Touch also features integrated balancing for six-cell, Lithium-Polymer (LiPo), Lithium-Ferrite (LiFe) and Lithium-Ion (Li-Ion) batteries.

Parts Layout



This unit is simple to use, but the operation of a sophisticated automatic charger such as the Hitec X1 Touch requires some knowledge on behalf of the operator. These operating instructions are designed to ensure that you can quickly become familiar with its functions and capabilities. It is important that you read this manual in its entirety before you attempt to use the X1 Touch charger for the first time.

Specifications

AC Input	100 - 240 Volts AC
DC Input	11-18 Volt DC
Charge circuit power	55 Watts
Charge current range	0.1 - 7.0 Amps
Discharge current range	5 Watts
Discharge current power	0.1-2.0 Amps
Current drain for balancing port	200mA per cell
NiCd/NiMH battery cell count	1-15 Cells
LiPo/LiFe/LiIon cell count	1-6 Cells
Pb battery voltage	2-20V
Net weight	19 oz.



**Touch Screen Interface System**

The X1 Touch is equipped with a 3.2" color touch sensitive LCD screen. Featuring an intuitive, easy-to-use setup system, the X1 Touch has all the important setup features conveniently located on the home screen.

**Charging Status Monitor**

When the charger is in use, all the important information is available for display on the screen. This enables the user to easily check a variety of information including the charging capacity, cell voltage, elapsed charging time, and the internal and external temperature. The X1 Touch also has the ability to display the charge voltage in a graph form which helps the user monitor the status of the charging process at any time.

**Optimized Operating Software**

The Hitec X1 Touch features an AUTO function that automatically adjusts the current during the charging and discharging operations. It can prevent overcharging which may lead to an explosion due to improper parameters set by the user, especially for Lithium batteries. The X1 Touch will disconnect the circuit automatically and produce an audible alarm upon detection of abnormal voltage or current loads. The X1 Touch is designed to increase operator safety by monitoring the voltage and current activity throughout the charge or discharge processes.

**Dual Power Input**

The X1 Touch has the ability to operate on a variety of power sources. The power source can be a 12 volt automotive-type battery, an 11 ~ 18 volt DC power supply, or a 100 ~ 240 volt AC household current.

**Internal Independent Lithium Battery Balancer**

The Hitec X1 Touch employs an internal, individual cell voltage balancer. It isn't necessary to connect a third party balancer for balance charging. Simply use the included Universal Balancing Board when connecting Lithium packs.

**Balancing of Individual Lithium Cells**

The Hitec X1 Touch can monitor and balance each cell individually while charging or discharging the battery. Error messages will be displayed on the screen and the process will terminate automatically if the voltage of any single cell is abnormal.

**Accommodates Most Popular Types of Lithium Chemistry Batteries**

The Hitec X1 Touch is capable of charging the most popular types of lithium chemistry batteries, including LiPo, Li-Ion and the new LiFe series of batteries.

**Fast and Storage Modes for Lithium Batteries**

The X1 Touch allows for Fast and Storage Modes for Lithium charging. Fast Mode reduces the overall charge time for quick turnaround at the field or track, keeping in mind that standard charging will result in a more complete charge at full capacity. Storage Mode allows for safe, longer term storage of lithium batteries. Storing LiPo batteries at full charge can increase the probability of cell damage and pack "puffing."

**Cyclic Charging/Discharging**

Continuous charge/discharge or discharge/charge functions are available to refresh or restore NiCd and NiMH battery capacity and performance. These cycles can be set to automatically repeat from 1 to 5 times.

**Data Store/Load**

The charger can store up to 5 different charge/discharge profiles for your convenience. Each profile can store settings for battery type and charge/discharge parameters. You can easily recall these saved profiles to increase simplicity and efficiency of common processes.

**Memory Preset**

The charger can store up to 5 different charge/discharge profiles for your convenience. You can keep the data pertaining to the program setting of the battery for continuous charging or discharging. Users can call out this data at any time without any special program setting.

**Termination Voltage Control**

The end charge voltage can be adjusted for each type of battery chemistry, up to the maximum safe limit.

**Battery Meter**

The battery meter displays the total battery voltage for Pb, NiMH and NiCd packs. For Lithium chemistry batteries, the X1 Touch displays the total pack voltage, individual cell voltage and the highest and lowest voltages for each cell.

**Re-Peak Mode of NiMH/NiCd Batteries**

In re-peak charge mode, the charger can automatically peak charge the battery once, twice or three times in a row. This is helpful for making sure the battery is fully charged and for checking how well the battery takes a charge.

**Delta-peak Sensitivity for NiMH/NiCd**

Delta-peak charging for NiMH and NiCd batteries monitors the pack's voltage and

terminates the charge when the pack reaches full capacity. You can adjust the peak mV setting to either increase or decrease the charger's sensitivity to the voltage drop that occurs when the pack nears full capacity.



A lower mV setting is more sensitive and will terminate the charge process earlier than a higher mV setting.

**Automatic Charging Current Limit**

You can set the upper limit of the charging current when charging your NiMH or NiCd batteries. This is useful for NiMH batteries of low impedance and capacity when charging in the 'AUTO' charging mode.

**Capacity Limit**

The charging capacity is always calculated as the charging current multiplied by time. If the charging capacity exceeds the limit, the process will terminate automatically when a maximum value is set.

**Temperature Threshold (requires optional temperature sensor, PN# 44159)**

NiCd and NiMH batteries become warm as the charge process completes. This is a normal condition and should be expected as the Delta-peak charge process completes the charging cycle. If the user inadvertently sets the mV sensitivity to an abnormally high value or if there is a problem with the battery (i.e, one or more bad cells in the pack), the battery temperature could exceed safe limits. If the external temperature limit option is enabled and the optional temperature sensor is installed and placed on the battery, the charge process will terminate if the user-set temperature limit is reached.



Lithium and Pb batteries should NEVER get warm during the charge process.

**Processing Time Limit**

Maximum charge and discharge process time limits can be set to protect against possible battery defects. This is highly recommended when charging Lithium chemistry batteries.

**Hitec Charge Master Software**

The free "Hitec Charge Master" software gives you unparalleled ability to operate the charger through the computer. You can monitor pack voltage, cell voltage and other data during charging and view charge data in real-time graphs. You can also initiate processes, control charging and update firmware from the "Hitec Charge Master" software.

Warning, Caution, Tip and Note Boxes



Warning



Tip

**Warning:** Be sure to read this section for your own safety.

**Caution:** Be sure to read this section to prevent accidents and damage to your charger.



Note



Caution

**Tip:** This section will help you maximize the performance of your charger.

**Note:** This section will provide more detailed explanations.

These warnings and safety notes are of the utmost importance. You must follow these instructions for maximum safety. Failure to do so can damage the charger and the battery; and in the worst cases, may cause a fire.



Caution

**NEVER LEAVE THE CHARGER UNATTENDED WHEN IT IS CONNECTED TO ITS POWER SOURCE. IF ANY MALFUNCTION IS FOUND, TERMINATE THE PROCESS AT ONCE AND REFER TO THE OPERATION MANUAL.**

- The allowable DC input voltage is 11-18V DC.
- The allowable AC input voltage is 100-240V AC.
- Keep the charger away from dust, damp, rain, heat, direct sunlight and excessive vibration.
- If the charger is dropped or suffers any type of impact, it should be inspected by an authorized service station before using it again.
- This charger and the battery should be put on a heat-resistant, non-flammable and non-conductive surface.
- Never place them on a car seat, carpet or similar surface. Keep all flammable volatile materials away from the operating area.
- Make sure you know the specifications of the battery to be charged or discharged to ensure it meets the requirements of this charger. If the program is set up incorrectly, the battery and charger can be damaged.
- Fire or explosion can occur due to overcharging.
- To avoid a short circuit between the charge lead, always connect the charge cable to the charger first, then connect the battery. Reverse the sequence when disconnecting.
- Never attempt to charge or discharge the following types of batteries:
  - A battery fitted with an integral charge circuit or a protection circuit
  - A battery pack which consists of different types of cells (including different manufacturer's cells)
  - A battery that is already fully charged or just slightly discharged and non-rechargeable batteries (these pose an explosion hazard)



- A faulty or damaged battery
- Batteries installed in a device or which are electrically linked to other components
- Batteries that are not expressly stated by the manufacturer to be suitable for the currents the charger delivers during the charge process

**PLEASE BEAR IN MIND THE FOLLOWING POINTS BEFORE COMMENCING CHARGING:**

- Did you select the appropriate program suitable for the type of battery you are charging?
- Did you set up the adequate current for charging or discharging?
- Have you checked the battery voltage? Lithium battery packs can be wired in parallel and in series, i.e. a 2-cell pack can be 3.7V (in parallel) or 7.4V (in series).
- Have you checked that all connections are firm and secure?
- Make sure there are no intermittent contacts at any point in the circuit.

**Standard Battery Parameters**

	LiPo	Lilon	LiFe	NiCd	NiMH	Pb
Nominal Voltage	3.7V/cell	3.6V/cell	3.3V/cell	1.2V/cell	1.2V/cell	2.0V/cell
Max. Charge Voltage	4.2V/cell	4.1V/cell	3.6V/cell	1.5V/cell	1.5V/cell	2.46V/cell
Storage Voltage	3.8V/cell	3.7V/cell	3.3V/cell	n/a	n/a	n/a
Min. Discharge Voltage	3.0-3.3V/cell	2.9-3.2V/cell	2.6-2.9V/cell	0.1-1.1V/cell	0.1-1.1V/cell	1.8V/cell



**WHEN ADJUSTING YOUR X1 TOUCH CHARGING PARAMETERS, BE SURE YOU SELECT THE PROPER BATTERY TYPE AND CELL VOLTAGE FOR THE TYPE OF CELL YOU ARE CHARGING. CHARGING BATTERIES WITH THE WRONG SETTINGS MAY CAUSE THE CELLS TO BURST, CATCH FIRE OR EXPLODE.**

**Charging**

Before charging your batteries, it is critical that you determine the maximum allowable charge rate for your batteries. The X1 Touch is capable of charging at high rates that may not be suitable or safe for your particular batteries. For example, Lithium cells are typically safe to charge at 1C, or the total mAh ÷ 1000. A 1200mAh battery would have a 1C charge rate of 1.2 amps. A 4200mAh battery would have a 1C charge rate of 4.2 amps. Some manufacturers are offering Lithium cells that can be charged at greater than 1C but this should ALWAYS be verified before charging a Lithium battery at rates higher than 1C. Voltage is just as critical as the charging amperage rate and this is determined by the number of cells in series, or "S". For example, a 3S LiPo is rated at 11.1 volts ("S" multiplied by a single LiPo cell with a nominal voltage of 3.7 volts DC. 3 cells x 3.7 volts each equals 11.1 volts DC).

Connect the battery's main leads to the charger output: red is positive and black is negative. Keep in mind that the gauge or thickness of your charging leads from the X1 Touch to your battery must be of an acceptable current rating to handle the applied charge current. For maximum safety and charging effectiveness, always match or exceed the main battery lead rating when assembling or selecting your charging leads. If you charge a battery at a high current rate (amperage) with a charging lead not rated for the chosen amperage, the wire could get hot, catch fire, short out and/or potentially destroy your battery and the charger. When in doubt, always use a higher gauge wire (lower AWG number). It is common to see charging leads constructed of 14AWG, 16AWG or 18AWG wire.

Always refer to recommendations from your battery manufacturer for your specific battery type and size before initiating a charge or discharge process.

Do not attempt to disassemble or modify Lithium or Lead-Acid battery packs.

**Discharging**

The X1 Touch discharging functions are for two specific purposes:

- Refreshing the capacity of a Nickel-based battery that has lost capacity over time (NiMH or NiCd).
- Reducing the voltage of a Lithium battery for safe storage.



**LITHIUM CHEMISTRY BATTERY PACKS SHOULD ONLY BE DISCHARGED TO THEIR MINIMUM SAFE VOLTAGE, NO LOWER. DEEP DISCHARGING A LITHIUM CELL WILL DO PERMANENT DAMAGE. REFER TO THE STANDARD BATTERY PARAMETERS TABLE ON PAGE 10 OF THIS MANUAL FOR MINIMUM DISCHARGE VOLTAGES.**

LiPo charge/discharge cycling – Lithium batteries are known to reach full capacity after a break-in period of about 10 charge/discharge cycles. We do not recommend you use the X1 Touch charger to do this, normal use and recharging will achieve the same results. If you wish to perform a Lithium break-in on the bench with the X1 Touch, discharging to minimum acceptable voltages and performing a balance charge at 1C maximum rate is recommended. If you choose to break in your Lithium batteries under normal use, charging at only 1C for the first ten cycles will help ensure full performance and service life from your Lithium cells.

The X1 Touch can be powered either from a wall outlet supplying 100-240VAC (50-60Hz) using the included AC power cord, or from a 12VDC automotive battery or an 11 ~ 18 volt DC, 30 amp power supply. If using an automotive-type battery, make sure it is fully charged before using the X1 Touch. A fully charged 12VDC automotive battery should have a nominal voltage of about 13.8V.



Using the supplied 4mm bullet connectors and ePower 30A power supply.



Using an AC power cord.



Using alligator terminal clips attached to a car battery.

**MAIN MENU**

When you power up the charger, you will see the following screen. This is the Main Menu (HOME) screen of the X1 Touch charger.

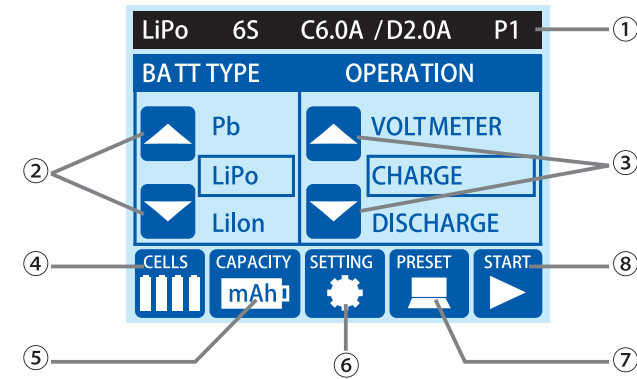

1. Indicates the current battery settings including: Battery Type / Number of Cells / Charge and Discharge current and if applicable, Preset Number.
2. BATT TYPE - Battery Type Selection Buttons (choose from LiPo, Lilon, LiFe, NiMh, NiCd and Pb).
3. OPERATION - Operation-Type Selection Buttons (Operation selections are dependent on the type of battery selected).
4. CELLS - Press to enter the Cell Count Selection Screen.
5. CAPACITY - Press to enter the Battery Capacity & Charge/Discharge Current selection screen.
6. SETTING - Press to enter the Settings Menu to set System Settings, Safety Protection and Charger Parameter Settings.
7. PRESET - Press to go to the Preset Screen, 5 different charge/discharge profiles are stored here.
8. START - Start button, press to begin the operation indicated on the operation menu.

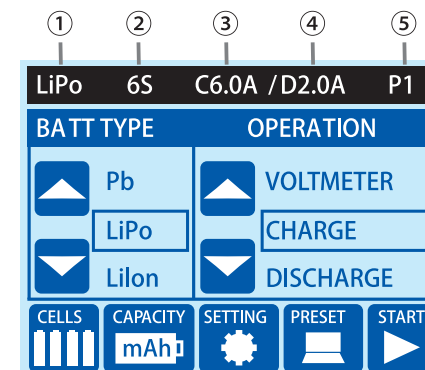

**Current Battery Setup**

1. Battery Type: LiPo/Lilon/LiFe/NiMH/NiCd/Pb
2. Battery Cell Count
3. Charging Current (0.1-7.0A)
4. Discharging Current (0.1-2.0A)
5. Preset Number (P1-P5)

**INPUT OPERATION**

**Browse** - Touch the arrows ▲ AND ▼ or ◀ AND ▶ to browse the selections.

**Select** - Touch your selection on the screen for confirmation.

**Start** - Touch the  button or touch and hold the operation program for 3 seconds to start the selected program.

**Enter** - Confirms data and takes you back to the previous screen.

**Next** - Takes you to the next setting screen.

**INITIAL SYSTEMS SETUP**

**Settings Menu**

Before you start using your charger, you may want to adjust the system settings to your liking. In the System Setup Menu, you can set System Settings, Safety Protection Settings and Charger Parameters. Use the ◀ and ▶ to go to the previous or next system setting and press "NEXT" to enter the selected program menu.

**Systems Menu**

In the Systems Setting menu, you can adjust a variety of preferences as indicated in the chart below.

ITEM	SELECTION	DESCRIPTION
KEY BEEP	ON/OFF	Turns On or Off the beeping sound that occurs when you touch a function key.
BUZZER	ON/OFF	Turns On or Off the sounds that occur during operation, alerting to different mode changes.
LCD LIGHT	1 ~ 5	Adjusts the brightness of the LCD screen.
THEME	Blue, Red, Yellow, or Green	Changes the color scheme of the touch screen inputs.
ABOUT	-	Displays Model / Serial Numbers and Hardware / Software versions.
RESTORE	YES / NO	Resets Charger to Default Factory Settings.

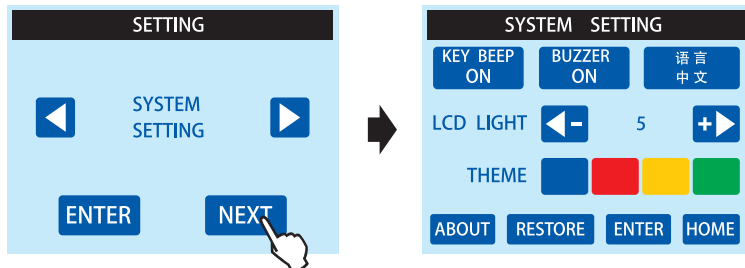

In the Safety Protection Settings Menu, you have the ability to set specific safety settings to further protect the charger against errors.



You should always check the safety settings prior to starting a charge or discharge process as the Safety Protection Settings values are always retained at the last set value.

ITEM	SELECTION	DESCRIPTION
CAPACITY CUT OFF	OFF 100-20000 mAh	Similar to the Safety Timer, Capacity Cut-Off allows you to limit the maximum charge capacity of the charging process. Limiting a charge process on a 1200mAh battery to 1300mAh, for example, can protect against extreme overcharging. Consult your battery manufacturer's recommendation for capacity limits.
SAFETY TIME	OFF 1-720 Minutes	The X1 Touch has an integrated safety timer for all charge processes. You can set the maximum charge time as a backup in the event the X1 Touch is unable to detect the proper charge cut off conditions. This can happen when charging faulty cells, exhausted packs, or packs exhibiting abnormal resistance or voltage fluctuations.
TEMP CUT OFF	20 C/68 F - 80 C/176 F	If you are using the optional external Temperature Sensor, you can set the temperature cut off. If you are not using the Temperature Sensor, leave this setting as is.

You can touch **CAPACITY CUT OFF** and **SAFETY TIME OFF** on the screen to turn these functions ON or OFF. To change the parameters, use the ◀- and ▶ keys.



The TEMP CUT OFF function can not be OFF. You must use the optional temperature cable for this function to operate.

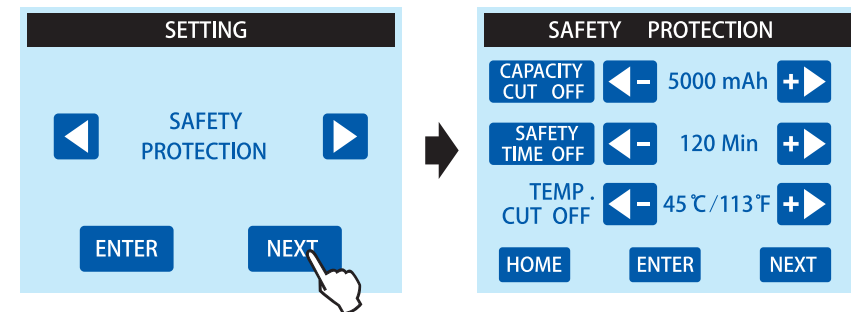



In this section, you can adjust the maximum voltage per cell during the charge process and the minimum voltage per cell for the discharge process. **THIS IS ONLY RECOMMENDED FOR ADVANCED USERS.**



By setting the END VOLTAGE CHARGE to any **POSITIVE SETTING** above the default value, you **ACCEPT ALL RESPONSIBILITY** for ANY DAMAGES, INJURY, or any other LOSS which may result. If you can not accept this responsibility, then **DO NOT OPERATE YOUR CHARGER UNLESS ALL TVC POSITIONS ARE SET TO THE DEFAULT VALUE!**

ITEM	SELECTION	DESCRIPTION
DELTA-PEAK SENSE	3 - 15 mV/Cell	AVAILABLE ONLY WHEN NiCd OR NiMH BATTERY TYPES ARE SELECTED. You can adjust the peak mV setting to either increase or decrease the charger's sensitivity to the voltage drop that occurs when the pack nears full capacity.
END VOLT CHARGE <b>WARNING</b>	LiPo 4.18 - 4.3V/Cell	This is the voltage level at which the X1 Touch will stop charging the battery. This feature allows LiPo and LiFe packs to be charged in excess of recommended cell terminal voltages. <b>THIS IS ONLY INTENDED FOR EXPERT USERS, ANY CHANGES TO DEFAULT SETTINGS ARE COMPLETELY AT YOUR OWN RISK.</b>
	Lilon 4.08 - 4.2 V/Cell	
	LiFe 3.58 - 3.7 V/Cell	
END VOLT DISCHARGE	LiPo 3.0 - 3.3V/Cell	This is the voltage level at which the X1 Touch will stop discharging the battery. It is displayed as volts PER CELL in the pack and not as total pack voltage.
	Lilon 2.9 - 3.2V/Cell	
	LiFe 2.6 - 2.9V/Cell	
	NiMH 0.1 - 1.1 V/Cell	
	NiCd 0.1 - 1.1 V/Cell	
REST TIME	Pb 1.8 V/Cell	AVAILABLE ONLY WHEN NiCd OR NiMH BATTERY TYPES ARE SELECTED. Rest time refers to the waiting period between cyclic discharge/charge processes. Nickel chemistry batteries benefit by having a "rest" period between cycles to allow the voltage to normalize between cells and let heat generated by the charge process to dissipate.
	1 - 120 Minutes	

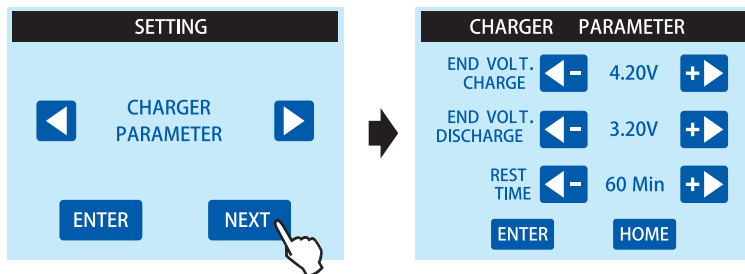

**Connecting the Battery**

To avoid short circuits between the banana plugs, always connect the charge leads to the charger first, and only then to the battery. Reverse the sequence when disconnecting the pack.

**Using the Balance Socket**

The X1 Touch package includes our Universal Balancing Board that accommodates most popular balancing connections. Plug the balancing board into the charger as shown below, then plug the battery into the proper socket on the balancing board, making sure the polarity is correct.

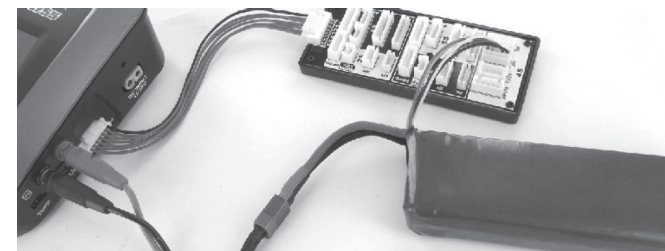

Failure to connect as shown in this diagram will damage the charger and/or battery.

**1. BATTERY SETTINGS**

There are three basic settings for your battery: Battery Type, Number of Cells, and Capacity and Current.

**Battery Type**

Use the up ▲ and down ▼ arrows on the screen to scroll through the 6 different battery types. The active selection will be highlighted by a frame around it, as shown here.

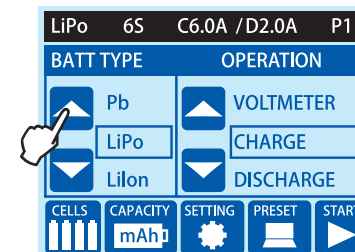

**Number of Cells**

Touch the CELLS icon to enter the cell selection screen. Use the ◀- and ▶+ to select the exact number of cells that are in your pack.

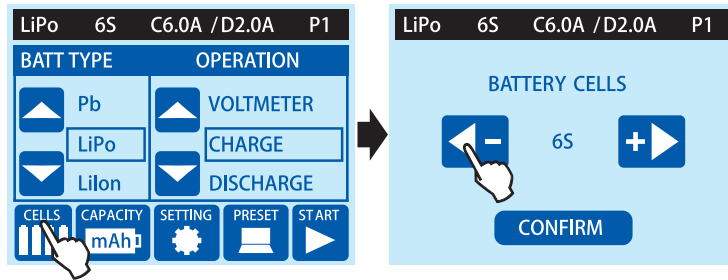

**Battery Capacity and Current**

Touch the CAPACITY icon to enter the cell selection screen. Use the ◀- and ▶+ to select the exact capacity of your pack. The battery capacity setting is interlocked with the charging and discharging amperage. These settings are based on a default 1C charge/discharge rate. Therefore when the battery capacity increases by 100mAh, the charging/discharging amperage will be increased by 0.1A. If your battery's manufacturer recommends a charge or discharge rate other than 1C, you can adjust those rates separately.

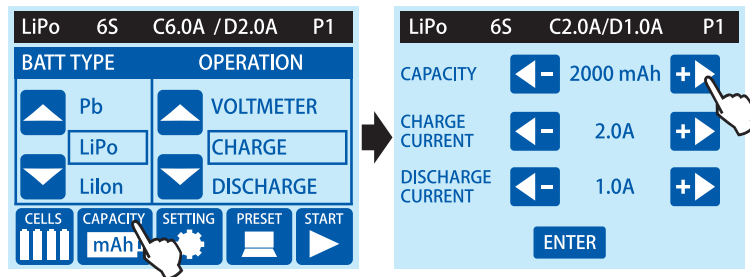

If your battery capacity is below 1000 mAh, such as an 850mAh pack, we recommend setting the capacity below the actual capacity (i.e. 800mAh).



Never use a Charge or Discharge Current setting that exceeds the manufacturer's recommendation.

**2. CHARGING PROGRAM**

The available program modes are dependent on the battery type used. The chart below lists the different operations available for each type of battery. Use the up ▲ and down ▼ arrows on the screen to find the program operation you wish to use.

BATTERY TYPE	PROGRAM OPERATION	DESCRIPTION
LiPo Lilon LiFe	CHARGE	This is the normal CHARGING mode for Lithium chemistry batteries.
	DISCHARGE	This is the normal DISCHARGING mode for Lithium chemistry batteries.
	STORAGE	Storage Mode is best used for charging or discharging Lithium chemistry batteries that will be stored for a long period of time.
	FAST CHG.	With Fast Mode Charging, the total charge capacity is reduced but the charge process will take less time.
	BAL. CHARGE	Balance Charging balances the voltage of each cell while charging. <b>Note: WE HIGHLY RECOMMEND CHARGING LITHIUM BATTERIES IN BALANCE MODE.</b>
	VOLT METER	Volt Meter is used to check the Lithium chemistry battery's total voltage, the highest and lowest voltage and each cell's individual voltage.
NiCd NiMH	CHARGE	This is the normal CHARGING mode for NiCd and NiMH batteries using the current set by the user.
	AUTO CHG.	In Auto Charge Mode, the charger automatically detects the connected NiMH or NiCd battery and determines the proper full charge and cutoff thresholds. <b>NOTE: Setting the upper charge current limit for safe levels based on your battery specifications will ensure safe charging of your specific battery.</b>
	DISCHARGE	This is the Normal Mode for discharging NiMH/NiCd batteries.
	RE-PEAK	In Re-peak Mode, the charger will automatically peak charge the battery once, twice or three times in a row. This process is good for confirming the battery is fully charged and for verifying how well the battery can accept a fast charge.
	CYCLE	In Cycle Mode, you can program the charger to automatically process up to 5 charge/discharge or discharge/charge cycles. This is helpful for refreshing and balancing the battery's performance.
	VOLT METER	The user can check NiCd or NiMH battery pack's total voltage.
Pb Lead Acid	CHARGE	Standard Charge Mode for Pb type batteries.
	DISCHARGE	Standard Discharge Mode for Pb type batteries.
	VOLT METER	The user can check Pb (Lead Acid) battery pack's total voltage.

**3. PROGRAM START**

Touch the start button or touch and hold the framed Operation Program for 3 seconds to start the program. The charger will check the number of battery cells automatically. If the detected result and your setting match, the charger will begin the selected operation.

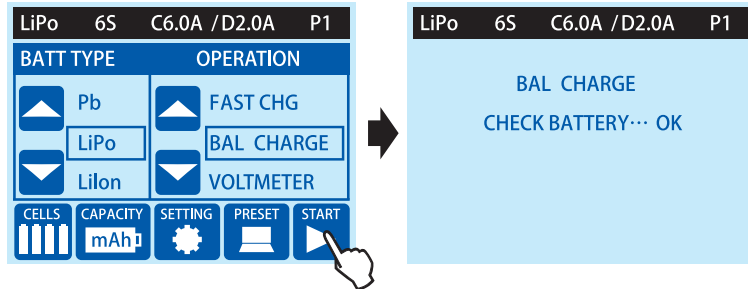

**Information Displayed during Operation**

Battery Information >	LiPo 6S C6.0A /D2.0A P1	
	BAL CHARGE	< Current Operations
Capacity Supplied >	CAPACITY : 40mAh VOL : 16.7V	< Pack Voltage
Elapsed Time >	TIME : 00: 02: 00 E.TEMP : 0°C	< External Temperature*
Charge/Discharge >	CURRENT : 2.0A I. TEMP : 36°C	< Internal Temperature
Current		
	BALANCE STATUS GRAPH STOP	*when used with optional temperature probe

If the settings are incorrect, an error message will be displayed. Touch the Home button to go back to the main menu and correct the setting before proceeding.

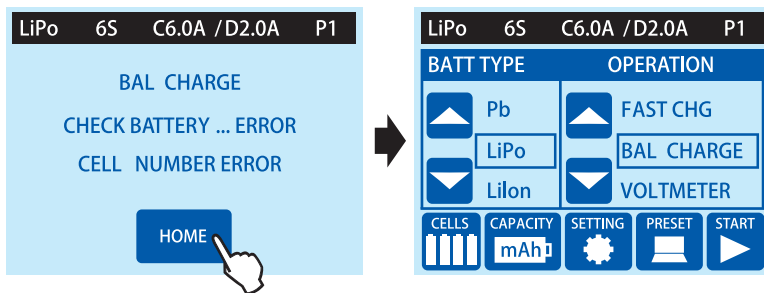

**4. PROGRAM STOP**

To stop the charge or discharge process, touch STOP. The process will stop and you will be taken back to the Main Menu

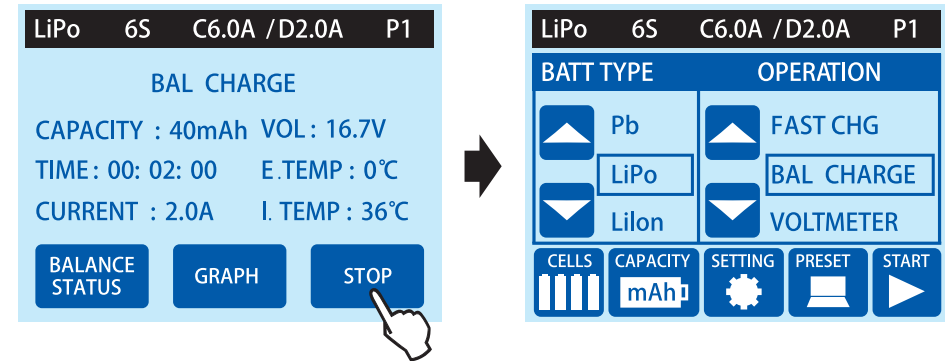

**5. PROGRAM COMPLETE**

When the program progress is completed, an audible sound will be heard and the charger will display the completed process information.

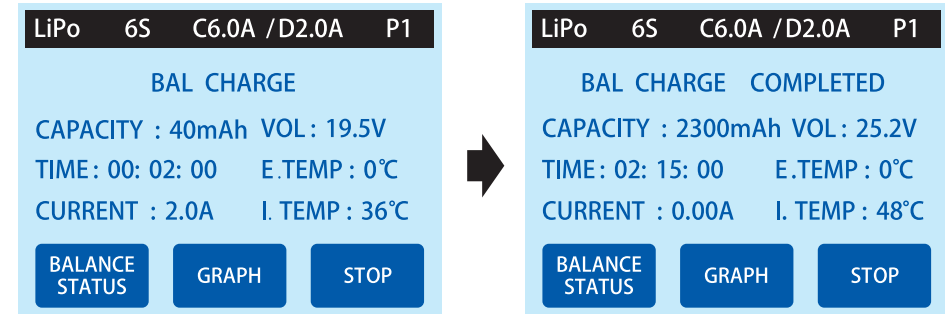

**INFORMATION DISPLAYED DURING OPERATION**

**1. CHARGING STATUS MONITOR**

When the charger is operating, the user can easily check the real-time status of the charging capacity, cell voltage, charging time, as well as external and internal temperatures.

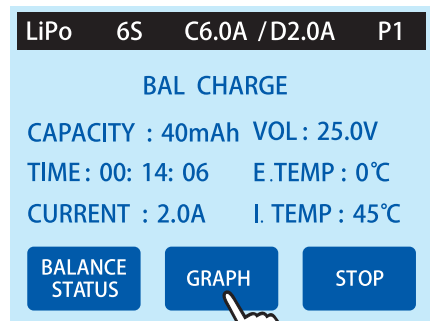

**2. GRAPH**

The X1 Touch also has the ability to display the total pack voltage in a graph which helps the user monitor the charging status. Touch "GRAPH" to show the charging or discharging curve.

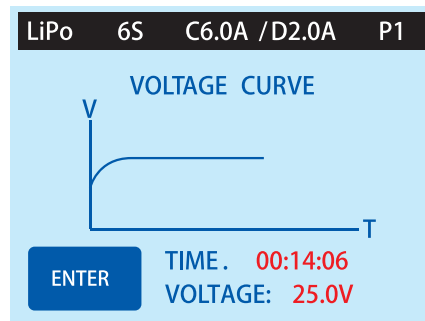

**3. BALANCE STATUS**

When charging Lithium chemistry batteries in balance mode, you can monitor the balance status and internal resistance of the battery pack.



Note: The internal battery resistance also includes the leads and connectors in the calculation.

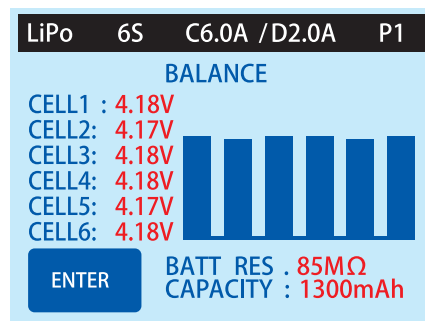
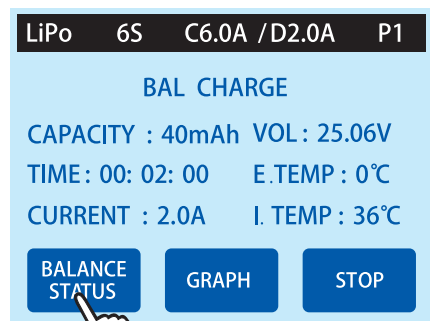

**USING THE CHARGE MASTER CHARGE CONTROL SOFTWARE**

Visit the Hitec RCD USA ([www.hitecrd.com](http://www.hitecrd.com)) website to download the free CHARGE MASTER software for Windows PC's. With the Charge Master software, you can control your charger settings, initiate the operation process, monitor a variety of processes, load data and update your charger's firmware.

**VOLT METER**

Using the VOLT METER function, you have the ability to check the total voltage of your battery pack. If you are checking a Lithium chemistry battery attached to a balancing board, you can also see the highest voltage, lowest voltage and each individual cell's voltage.

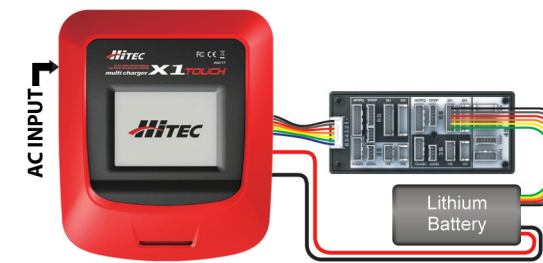
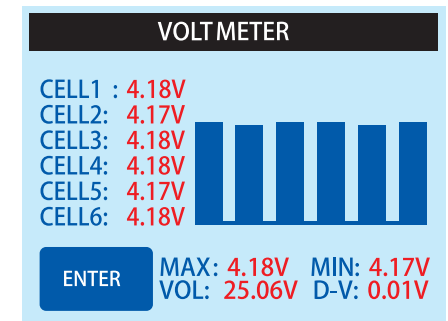
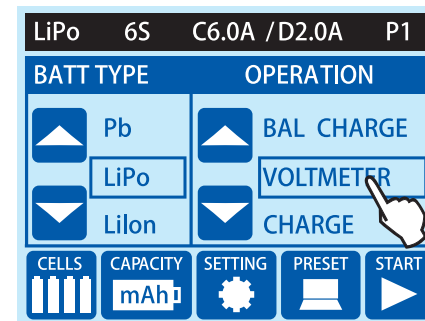

Connecting a Lithium chemistry battery attached to a balance board to see individual cell voltages.



Connecting a battery directly to the charger to see the total voltage of a pack.

**MEMORY PRESETS – DATA STORE/LOAD**

The X1 Touch charger can store up to 5 different charge/discharge profiles for your convenience. These stored profiles can be recalled quickly without having to go through the setup process.

**1. STORING PRESETS**

Enter the Presets menu and touch edit next to the preset you would like to create. Select the Battery Type, Number of Cells, Operation, Charge Current and Discharge Current, then touch CONFIRM to save the data and return to the previous screen.

**2. RECALLING DATA**

In the PRESET menu, the basic settings of the profiles are displayed. To use a preset, touch the desired preset settings bar to select it. You will then be returned to the Main Menu and the setting of the selected preset will be displayed at the top of the screen. Press start to execute the operation.

**ERROR MESSAGES**

The X1 Touch incorporates a variety of functions to verify the operation and the state of the electronics. In the event of an error, the error screen will display the cause of the error and emit an audible sound.

INT. TEMP TOO HIGH	The internal temperature of the unit is too high, terminate the process and allow the unit to cool down.
EXT. TEMP TOO HIGH	The temperature detected by the external temperature probe has exceeded the limit set by the user.
DC IN TOO LOW	Input voltage is less than 11V.
DC IN TOO HIGH	Input voltage is higher than 18V.
OVER TIME LIMIT	The charging time has exceeded the maximum charging time set by the user.
OVER CAPACITY LIMIT	The battery capacity has exceeded the maximum capacity set by the user.
REVERSE POLARITY	Incorrect polarity detected.
CONNECTION BREAK	The battery connection has been lost or interrupted.
CELL NUMBER ERROR	The cell number entered during setup is incorrect.
BALANCE CONNECTER ERROR	The balance connection is wrong. Check the connections and try again.
NO BATTERY	There is no battery connected to the charger.
CONNECTION ERROR	There is an error in the battery connection, check connection and try again.
BATTERY WAS FULL	When Charging in balance mode, the charger has detected that the cell voltages have exceeded the user's specified voltage.

The Hitec X1 Touch satisfies all relevant and mandatory EC directives and FCC Part 15 Subpart B:2008.

This product has been tested to meet the following technical standards:

	Test Standards	Title	Result
CE-LVD	EN60335-2-29	For safety of household and similar electrical appliances	Conforms
CE-EMC	EN55014-1	Electromagnetic compatibility-requirements for household appliances, electric tools and similar apparatus - Part 1: Emission	Conforms
	EN55014-2	Electromagnetic compatibility-requirements for household appliances, electric tools and similar apparatus - Part 2: Immunity-Product family standard	Conforms
	EN1000-3-2	Limits-Limits for harmonic current emissions (equipment input current < 16A per phase)	Conforms
	EN1000-3-3	Limits-Limitation of voltage chargers, voltage fluctuations and flicker in public low-voltage supply systems, for equipment with related current < 16A per phase and not subject to conditional connection	Conforms
FCC	FCC Part 15	Electromagnetic compatibility (EMC), Conduction Emission & Radiation Emission	Conforms



This symbol indicates that when this type of electronic device reaches the end of its service life, it cannot be disposed of with normal household waste and must be recycled. To find a recycling center near you, refer to the internet or your local phone directory for electronic waste recycling centers.



**STATE OF CALIFORNIA PROPOSITION 65 WARNING:**

This product contains chemicals known to the State of California to cause cancer. Use caution when handling this product and avoid exposure to any electronic components or internal assemblies.







[www.hitecrd.com](http://www.hitecrd.com)

MADE IN CHINA

